

ENGLISH

C O D I C O [®]

impulse ^{2/2023}

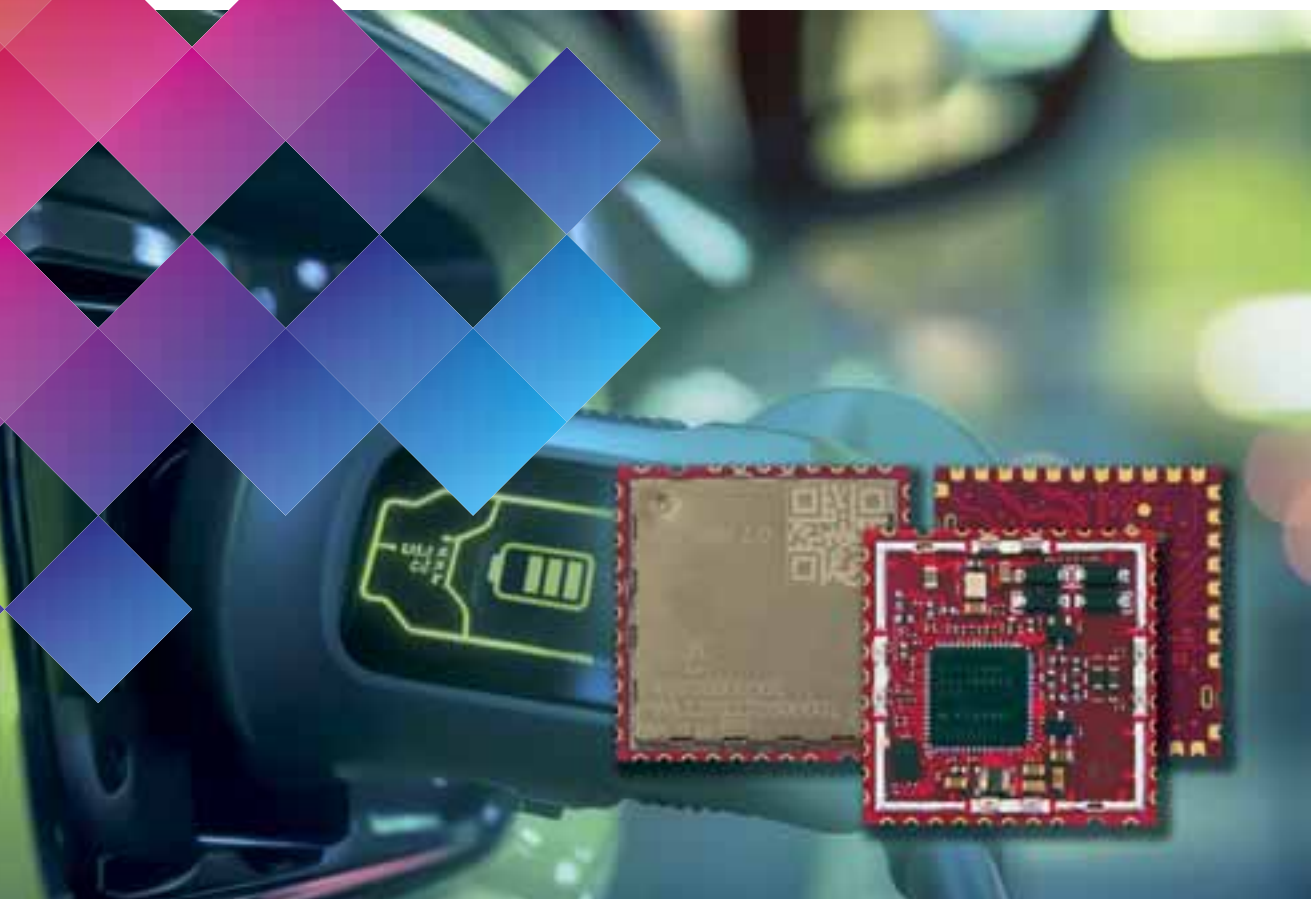

8DEVICES: RED-BEET-X 2.0

ALTRAN MAGNETICS: DC High Voltage Contactors

Zero8 – Zero Limits with EPT Connectors

CONTENTS

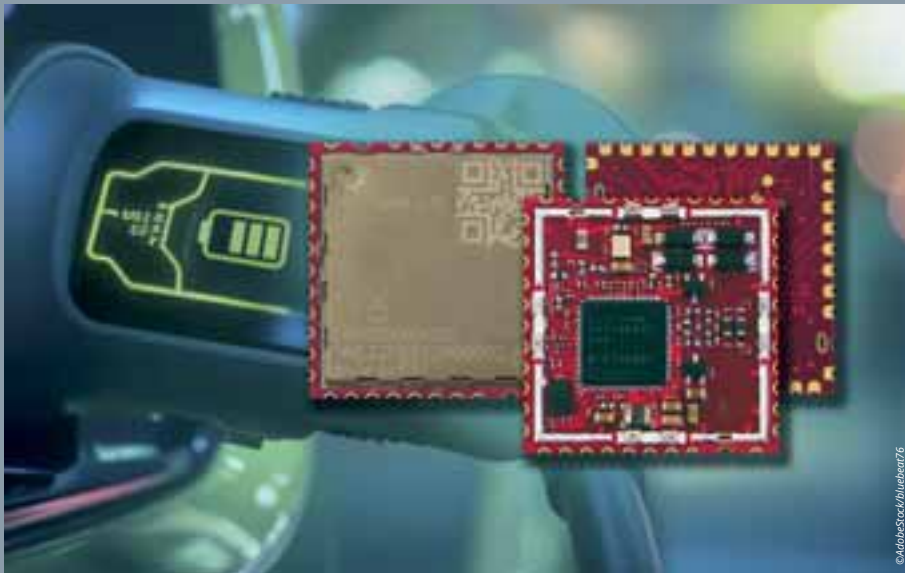

09 | RED-BEET-X 2.0

CODICO and 8DEVICES have developed an innovative series of modules based on the latest QUALCOMM PLC chip. These components have been specifically designed for electric vehicle charging applications and address the growing demand for enhanced and more powerful Home-Plug Green Phy PLC solutions.

ACTIVE COMPONENTS

- 04** | 8DEVICES starts a New Wi-Fi Module Offensive
- 09** | RED-BEET-X 2.0: New QCA Based PLC Module from 8DEVICES
- 10** | Structure & Function from OLED-Displays
- 14** | MPS: Accuracy and Resolution for Magnetic Angle Sensors
- 17** | »New Kids« on »Golden Blocks« Ag6130-LPB from SILVERTEL
- 18** | EZmotion presents the All-In-One-Motors
- 21** | RECOM's REM60-W: DC/DC Module for Highest Medical Standards
- 22** | XCL233 from TOREX: Ultra-Low Power 150mA Buck Micro DC/DC
- 24** | SYNAPTICS Multimedia-SoCs: The Target – Edge AI Market
- 27** | FN-LINK expands its Range of Wi-Fi6 Modules



PASSIVE COMPONENTS

- 28** | ALTRAN MAGNETICS DC High Voltage Contactors
- 30** | For High-Power Applications: EATON's Bolt-Down Fuses
- 32** | More Power with EATON's new MTA Series
- 33** | For sophisticated Designs: SUN's 16V Hybrid Capacitors
- 34** | SANYOU's 4-pole AC Charging Relays for Electric Vehicles
- 36** | ISABELLENHÜTTE: Requirements for DC Meters up to 50kW
- 38** | All your Clock needs – 32.768kHz Products from KDS
- 40** | RUBYCON's High-Voltage DC Link Capacitors
- 43** | ZTU Series from PANASONIC: High Ripple Current Capability

CONNECTORS

- 44** | AMPHENOL's MicroSpace™ High Voltage Connectors
- 46** | Single Pair Ethernet Circular Push-Pull Connectors from AMPHENOL
- 47** | Uncomplicated Wiring with DINKLE's P-LUP
- 48** | DF51 Series from HIROSE
- 49** | HIROSE: High Heat and Vibration Resistant Wire-to-Board Connector
- 50** | Connectors with 125°C Heat Resistance from HIROSE
- 51** | The Y-Lock Pullforce Connector System from YAMAICHI
- 52** | Zero8 – Zero Limits with EPT
- 54** | SINBON's PVC-free Cable Assemblies for your Choice
- 56** | Battery Swapping by SINBON
- 59** | INARCA INAR – IDC RAST connectors

CODICO IN-HOUSE

- 60** | Vienna Business Run 2023
- 61** | CODICO Quality Award
- 62** | CODICO Team

IMPRINT: Issued by CODICO GmbH Zwingenstraße 6-8, A-2380 Perchtoldsdorf
 Responsible for the content: Sven Krumpel | Editorship: Birgit Punzet
 Design: www.rittbergerknapp.com | date of issue: 02-01123
 Print: Gutenberg Druck – Kooperationspartner der Print Alliance HAV
 Produktions GmbH, Druckhausstrasse 1, 2540 Bad Vöslau

Editorial

Sven Krumpel
CEO CODICO



BATTLE



ChatGPT

☰
New chat
+

Write an editorial for a customer magazine named Impulse.

➤



Dear readers,

It gives me great pleasure to welcome you to the new issue of our customer magazine. In this issue we would like to provide you again with interesting articles, exciting stories and useful information from the world of our company and beyond.

Our customers are at the heart of everything we do, and this magazine is a way of expressing our appreciation for your trust and loyalty. It is intended not only to keep you up to date with our latest products and services, but also to provide an insight into our corporate culture, values and mission.

In this issue, you will come across inspiring stories from customers who have positively impacted our products and services in their lives. We will also give you insights into the innovative power of our company and how we continuously work to exceed your expectations.

In addition, we have prepared expert contributions on various topics that will offer you useful tips and advice, be it in the field of technology, health, finance or lifestyle.

We invite you to enjoy this issue at your leisure and hope that you will find valuable information and inspiration that will be useful in your everyday life. Your feedback is very important to us, so we encourage you to share your thoughts, suggestions and ideas with us so that we can continuously improve our customer magazine.

Thank you for being part of our customer community and we look forward to a continued successful and cooperative partnership.

Best regards,
ChatGPT

Dear readers,

Today we are going to conduct an experiment. I am battling myself with ChatGPT. At first, I thought I could only lose. But now, I am convinced that there can be no winner or loser here. I may be able to convey human authenticity, empathy, morality and ethics. But my colleague (male, because the chatbot) on my left was much faster – he managed the text in 20 seconds.

Personally, I felt remorse writing this preface. ChatGPT didn't. No reflection, no misgivings, no morals. But I seriously wonder if I should really open the gates for AI in our customer magazine here. The work on the next few pages is man-made. Our product managers have worked with our manufacturers to create the content for the following articles. They have collected, analysed and summarised information and compiled images. Our marketing team has thought about the editorial planning and implementation, the layout and the picture language. This is a work that many people have created together. This work is what makes us special and also reflects our strategic approach.

As soon as we move to a thematic level in content creation, ChatGPT draws from a never-ending source of data. It would only take him a few seconds to create a text even for a technical article. I would have to – assuming I had basic know-how on a topic – start with research work and analyses, evaluate them, interpret them correctly, summarise them, embed them in a structure, work with different sources, draw my own conclusion. Therefore, I would have to put a lot of work into this. That's exactly what we do on the next few pages. Research for you, work out a solution for you, show you the best in a technical development and make that available to you.

My advantage is that my thoughts can develop as I write. My colleague on my left is content with the initial question. I engage thoughts spontaneously, while ChatGPT is limited to pre-programmed algorithms.

No further use of AI is planned for me at this point. We want to stay in touch with you, on a personal level. We stand for responsibility – and I can always stand behind my personal word.

Enjoy reading this issue of Impulse! And thanks to all the editors who take the trouble to create content here themselves!

➤ *Sven Krumpel*

NEW MODULES

8DEVICES starts a New Wi-Fi Module Offensive



In 2023, 8DEVICES is taking off again and surprises with a range of new, innovative and future-proof Wi-Fi modules, which will be presented in the following article.

As always, all modules are offered with CE, FCC and IC certificates and you can find a complete overview as well as datasheets on our support page:
<http://downloads.codico.com/misc/AEH/8Devices>

Samples and DVKs are in stock and can be ordered directly from the product matrix.

Carambola3

1

Wi-Fi4 SOM

By far the most successful Wi-Fi SOM (System on Module) from 8DEVICES is called Carambola2 and is still thriving in the market after more than 10 years. However, many customers have asked themselves whether there will be a successor that has more to offer in terms of performance. This year, the time has finally come and 8DEVICES proudly announces the launch of Carambola3.

Carambola3 is also a Wi-Fi4 SOM and is very similar to its predecessor Carambola2. It is pin-to-pin compatible, meaning it has the same physical dimensions and pinouts. This allows easy integration of Carambola3 into existing systems already using the Carambola2 module without having to go through a HW redesign.

Since Carambola3 is based on QUALCOMM's newer QCA4531 device (Carambola2 is based on the AR9331@400MHz), a higher CPU clock of 650MHz is available, resulting in 60% more processing power. Together with the expansion of the Flash memory from 16MB to 32MB and the DDR2 RAM memory from 64MB@200MHz to 128MB@300MHz, it is now possible to integrate more memory-intensive and complex applications that were previously not sufficiently supported on the Carambola2. In addition, up to 64

clients can now be operated in access point mode instead of just 32. It is also pleasing to see, that the QCA4531 is based on the same MIPS 24K processor architecture as the AR9331. Thus, the expenditure for a SW porting under OpenWRT from Carambola2 to 3 is very low.

Like Carambola2, Carambola3 is also offered in two temperature versions. A feature list and a comparison of the two modules can be found in the table below.

Part Number		Carambola2 Carambola2-I	Carambola3 Carambola3-I
			
Platform	SoC	AR9331-AL1A AR9331-AL1F	QCA4531-BL3A QCA4531-BL3B
	CPU	MIPS 24K@400MHz	MIPS 24K@650MHz
	Flash	16MB NOR	32MB NOR
	RAM	64MB DDR2@200MHz	128MB DDR2@300MHz
	OS	Linux OpenWRT	Linux OpenWRT
Connectivity	Ethernet	2x 100 Base-T	2x 100 Base-T
	USB	USB2.0	USB2.0
	PCIe	no	no
	Serial Interfaces	I2S, SPI, SLIC, SPDIF, UART	SPI, UART
	GPIOs	23x GPIOs	19x GPIOs
	JTAG	yes	yes
	Miscellaneous	no	no
Wireless	Standards	Wi-Fi4	Wi-Fi4
	MIMO	1x1	1x1
	Frequency	2.4Ghz	2.4Ghz
	Bandwidth	HT20/HT40	HT20/HT40
	Antenna Data Rate	150Mbps	150Mbps
	Antenna Options	1x U.FL or 1x Pin	1x U.FL or 1x Pin
	Output Power	21dBm	21dBm
	No. of Clients	32	64
Module Spec	Power Supply	3.3V	3.3V
	Dimension (mm)	28x38	28x38
	Weight (g)	6,4	5
	Temperature Range	0°C to +65°C -40°C to +85°C	0°C to +65°C -40°C to +85°C
	Mounting	single side	single side
	Package	LGA	LGA
	Certifications	CE, FCC, IC, Teleg, KCC	CE, FCC, IC





©AdityaSoc/Damian

Cherry

2

Wi-Fi6 SOM

Cherry is the name of the new Wi-Fi6 SOM (System on Module) and can be seen as the »little brother« of Mango. It is in fact a much slimmed-down variant, in which the developers have set themselves the ambitious goal of achieving a particularly small form factor in order to satisfy the growing demand for small-case Wi-Fi6 APs and gateways in IoT applications.



Cherry is based on QUALCOMM's new IPQ-5000 SoC, which features two Cortex-A53 CPUs instead of four compared to the IPQ-60xx family on which Mango is based. The clock rate has also been throttled from 1.8GHz to 1GHz in this device version. In return, IPQ-5000 has an integrated 256MB DDR3L memory, as well as an integrated 1GE PHY, which allows the realisation of a particularly small module design. Measuring just 30.5x9.4mm, Cherry takes up only ¼ of the size of Mango. Of course, the customer has to make some compromises with such a small design. For example, the Wi-Fi6 radio functions are limited to the 2.4GHz band, but at least it supports 2x2 MU-MIMO, 1024 QAM (2SS) with HT20/HT40 with a maximum antenna data rate of 573Mbps. Via the PCIe 2.0 interface, the module can easily be upgraded to 5GHz and/or 6GHz bands with appropriate radio chips (e.g. QCN-9074, QCN9072 from QUALCOMM) or radio modules (e.g. MiniPini or Pineapple). Two U.FL connectors are integrated for connecting two antennas.

Just like Mango, the customer has to use an external NAND memory for his application code, which is connected to Cherry via QSPI NAND interface. Cherry can be expanded to 2.5GE via an external PHY using the SGMII interface, allowing

parallel operation of 1GE and 2.5GE. Cherry is limited to a commercial temperature range of 0°C to +65°C, i.e. no industrial version will follow. This can be attributed to the fact that the IPQ-5000, in contrast to the IPQ6010, is only

offered by QUALCOMM in the commercial temperature grade.

A direct comparison of Cherry and Mango features can be found in the following overview:

Part Number		Cherry	Mango Mango-I
			
Platform	SoC	IPQ-5000-0-DRQFN180B-TR-01-0	IPQ-6010-0-FCBGA570-TR-00-0 IPQ-6010-1-FCBGA570-TR-00-0
	CPU	Dual Cortex-A53@1GHz	Quad Cortex-A53@1.8GHz
	Flash	32MB NOR & QSPI NAND interface	32MB NOR and parallel NAND (external)
	RAM	256MB DDR3L	512MB DDR3@933MHz
	OS	Linux OpenWRT	Linux OpenWRT
Connectivity	Ethernet	1GE and 2.5GE ¹	[2x 2.5GE] or [1x 2.5GE + 4x 1GE] or [5x 1GE] ²
	USB	no	USB3.0, USB2.0
	PCIe	PCIe 2.0	PCIe3.0
	Serial Interfaces	I2S, SPI, UART, I2C, etc.	6x BLSP (SPI/UART/I2C configuration ports), 4x PWM, SDIO3.0
	GPIOs	26x GPIOs	50x GPIOs
	JTAG	yes	yes
	Miscellaneous	no	eMMC, Parallel NAND and MIPI DBI v2.0 type B interface
Wireless	Standards	Wi-Fi6	Wi-Fi6
	MIMO	MU 2x2	Multi User 2x2 DBDC
	Frequency	2.4Ghz	2.4GHz & 5GHz
	Bandwidth	HT20/HT40	HT20/HT40/HT80
	Antenna Data Rate	573.5Mbps	1021Mbps@5GHz, 573.5 Mbps@2.4GHz
	Antenna Options	2x U.FL	2x Pin
	Output Power	23dBm	21 dBm@5GHz, 22dBm@2.4GHz
	No. of Clients	128	256
	Power Supply	3.3V	3.3V
Module Spec	Dimension (mm)	19.4x30.5	38.3x61.7
	Weight (g)	5	15
	Temperature Range	0°C to +65°C	0°C to +65°C -40°C to +85°C
	Mounting	dual side	dual side
	Package	LGA	LGA
	Certifications	CE, FCC, IC	CE, FCC, IC

¹ Integrated 1 GE PHY. For 2.5 GE an, ² Requires external Ethernet PHY QCA8075 or QCA8081 external PHY via SGMII is required

3

MiniPini25

Wi-Fi6 Radio Module in Mini-PCle Form Factor

Already since 2022 8DEVICES offers Wi-Fi6 PCIe radio modules for AP, router and gateway solutions. These modules are available as LGA or PCIe plug-in cards and since then have become very well known in the market under the name Pineapple. Due to the high popularity and the increasing demand of small formfactor modules, 8DEVICES is expanding its Wi-fi6 product portfolio this year with mini-PCle modules.

MiniPini25 is the name of the new module family. Already the first syllable »Mini« indicates that it is a miniaturisation of the existing module generation. In addition to the new form factor (50.95x30mm), the new module family also offers Dual Band Selectable, i.e. the modules can be operated either on 2.4GHz or 5GHz, hence the name MiniPini25. In comparison, Pineapple always supports only one band: 2.4 GHz (Pineapple2), 5 GHz (Pineapple5) or 6 GHz (Pineapple6). The miniaturisation and dual band capability entail the compromise that the maximum output power is limited to 20dBm (per chain). For applications requiring a high output power of up to 28 dBm, the Pineapple family continues his right of existence within the Wi-Fi6 product portfolio. MiniPini25 are offered with four or two antennas. In the 2-antenna version (2x2), the smaller variant

Part Number		MiniPini25 MiniPini25-I, 2x2	MiniPini25 MiniPini25-I, 4x4
			
Platform	IC Part Number	QCN-9072-0/1-MSP234-TR-01-0	QCN-9074-0/1-MSP234-TR-01-0
	Interface Wi-Fi	PCIe 3.0, mini-PCle	PCIe 3.0, mini-PCle
	Linux / Android	QSDK/ath11k	QSDK/ath11k
	Linux Mainline Kernel	from 5.4 upward	from 5.4 upward
	Windows Support	no	no
Wireless	Wi-Fi Standards	Wi-Fi6	Wi-Fi6
	MIMO	MU 2x2	MU 4x4
	Frequency	2.4GHz & 5GHz	2.4GHz & 5GHz
	Bandwidth	HT20/HT40/HT80 /HT160	HT20/HT40/HT80 /HT160
	Antenna Data Rate	up to 2402Mbps	up to 4804Mbps
	Antenna Options	2x U.FL connectors	4x U.FL connectors
	Output Power	20dBm	20dBm
	No. of Clients	512	512
Module Spec	Monitor Mode	yes	yes
	Power Supply	3.3V	3.3V
	Dimension (mm)	50.95x30	50.95x30
	Weight (g)	28	28
	Temperature Range	0°C to +60°C -40°C to +85°C	0°C to +60°C -40°C to +85°C
	Mounting	dual side	dual side
	Package	mini PCIe card	mini PCIe card
Certifications		RED, FCC, IC	RED, FCC, IC

QCN-9072 from QUALCOMM is integrated instead of QCN-9074 (4x4) and accordingly only two front ends are implemented instead of four. Just like Pineapple, the MiniPini25 are also offered in commercial and industrial temperature range,

the latter being indicated by an -I (MiniPini25-I) in the name.

An overview of all relevant features can be found in the table above.





Noni

4

Wi-Fi7 Radio Module in M.2 Form Factor

Noni is based on the brand new Wi-Fi7 MIMO4x4 radio chip QCN-9274 from QUALCOMM and operates with a Linux-based host processor via a PCIe 3.0 interface with 2 lanes through a M.2 slot. In 5GHz operation, Noni supports a maximum PHY rate of 8647Mbps (240MHz bandwidth) and is IEEE 802.11 be/ax/ac/n/a compliant. In the 6GHz band, Noni even achieves a maximum PHY rate of 11529Mbps (320MHz bandwidth) and is compliant with IEEE 802.11 be/ax.

Noni has also the special feature that, in addition to single-radio operation in MIMO4x4, it also supports dual-radio operation, in which the MIMO4x4 configuration is split down into two MIMO2x2. In this case, two antennas can operate arbitrarily in the 4.9-7.125GHz band and the two remaining can operate arbitrarily at the same time in the 4.9-7.125GHz band as well. Thus, Noni is fully DBS (Dual Band Simultaneous) capable in this so-called split mode.

Part Number		Noni Noni-I
		
Platform	IC Part Number	QCN-9274-0/1-MSP264-TR-01-0
	Interface Wi-Fi	PCIe 3.0, dual lane
	Linux / Android	QSDK/ath12k
	Linux Mainline Kernel	from 6.4.x upwards
	Windows Support	no
Wireless	Wi-Fi Standards	Wi-Fi7
	MIMO	MU 4x4 or [2x2 & 2x2]
	Frequency	5GHz & 6GHz (4,9GHz - 7,125GHz)
	Bandwidth	HT5 to HT320
	Antenna Data Rate	up to 11Gbps
	Antenna Options	4x U,FL connectors
	Output Power	up to 22dBm
	No. of Clients	512
Module Spec	Monitor Mode	yes
	Power Supply	3.3V
	Dimension (mm)	30x42
	Weight (g)	18
	Temperature Range	0°C to +65°C -40°C to +85°C
	Mounting	dual side
	Package	M.2 3042 A+E Key
Certifications	RED, FCC, IC	

Other special features include high output power of up to 22dBm per chain and support for 5 and 10MHz channels in the 4.9GHz band (Public Safety Band). Noni is offered in commercial (Noni) and industrial temperature range (Noni-I).

An overview of all relevant features can be found in our table.

A01

▶ André Ehlert, +49 89 1301438 11
andre.ehlert@codico.com

RED-BEET-X 2.0



New QCA Based PLC Module

The demand for HomePlug Green Phy PLC Modules with improved features, such as a higher operating temperature range and improved quality control during production is increasing.

CODICO and its long-standing partner 8DEVICES have now developed a new series of modules, based on Qualcomm's latest PLC-Chip – the QCA7006AQ –, that addresses the needs for electric vehicle charging applications (on both EV and EVSE).

RED-BEET 2.0 is a universal powerline communication module which provides SPI and Ethernet interfaces to the user to allow higher HomePlug AV (HPAV) data rate connectivity applications separate from HomePlug Green PHY (HPGP)

communication. It provides best in class Analog Front End noise performance, thermal management with max. operating temperature of +105°C (ambient) and high quality by doing Automated Optical Inspection during manufacturing.

There are 3 different versions of the module available and despite primary focus on eMobility (EVSE and PEV) it also fits perfectly for smart grid, smart meter, IoT and other long-range communication applications.

- **RED-BEET-H 2.0**
For IoT, smart grid/meter, long range PLC
- **RED-BEET-E 2.0**
For Electric Vehicle Supply Equipment – EVSE
- **RED-BEET-P 2.0**
For Plug-in Electric Vehicle -PEV

HIGHLIGHTS

- Based on Qualcomm QCA7006AQ all-in-one, automotive-grade HPGP/HPAV PLC chip
- Compliant with ISO 15118-3, HPGP and HPAV standards
- Fully interoperable with IEEE 1901 specifications products
- Based on OFDM (Orthogonal Frequency Division Multiplexing) with 1.8MHz to 30MHz spectrum (2MHz to 28MHz on radiating wires and in eMobility)
- Extended PHY rate 9.8Mbps via HPGP (QPSK) & 200Mbps via HPAV (16, 64, 256, 1024 QAM)
- Host interfaces SPI slave, Ethernet with embedded 10/100 Ethernet PHY, UART
- Extended operating temperature range -40°C up to +105°C (ambient)
- Automotive Grade components used on module
- Serial Flash on module with latest HPAV/HPGP Firmware and configuration file (PIB)
- Available configurations EVSE, PEV and IoT/Home Control;
- Single power supply 3.3V DC with on-chip integrated power management unit
- Power consumption appr. 1W (SPI) / 1,2W (Ethernet) (both at +25° C)
- -95dBm Analog Front End noise performance
- 23.3x23.3mm, 40-Pin package
- Castellated vias for enabling of AOI on host PCB, improved mechanical stability, simplified testing
- Optical Inspection to enhance product quality
- Long term availability

All components on the module are AEC-Q100/200 Automotive qualified making it suitable even for high-end automotive applications. Samples are available at CODICO. For further requests please contact:

A02

▼ Werner Reis, +49 81 41357 264
werner.reis@codico.com

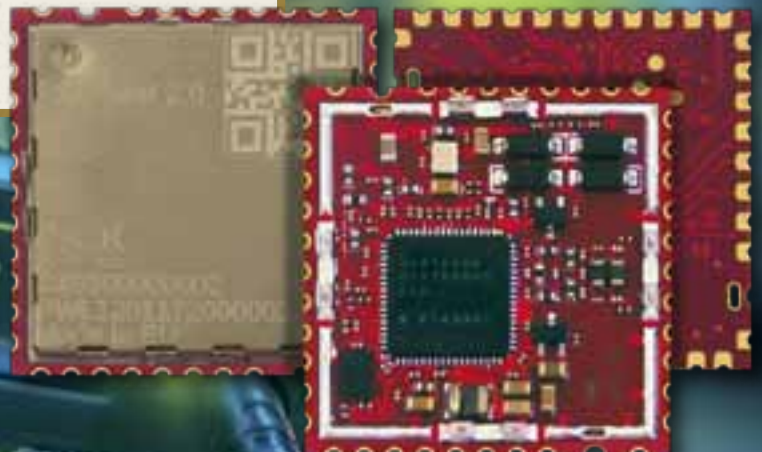



OLEDs

OLED display – everyone has heard the term, but do we really know what it means? Mostly, the concept appears in connection with mobile phones or TV sets and suggests a technology that offers advantages. It is advertised as having brilliant colours, low power consumption and much more. But is this really true?

Structure & Function

OLED displays consist of organic light-emitting diodes, i.e. semiconductors made of layers of organic materials that are only a few nanometres thick (they are about 200 times thinner than a human hair). The layers are embedded between two conductive electrodes – anode and cathode. The main components of an OLED are thus substrate, anode, cathode and the organic layers - transport and emitting layer (Figure 1). In practice there are a few more layers, but for the sake of simplicity we will limit ourselves to the essentials.

So how do these layers produce visible light? To make the OLED glow, a voltage is applied between anode and cathode. When current starts to flow, the cathode receives electrons from the current source and the anode loses electrons to

the source. You can also say the anode receives holes. The added electrons charge the emitting

layer negatively, while the conducting layer is charged positively. This is comparable to the n- and p-doped layers of a silicon or germanium diode.

Positive charges (holes) are more mobile than negative electrons, so they jump over the boundary from the conducting layer to the emitting layer. If a positive charge (hole, i.e. a missing elec-

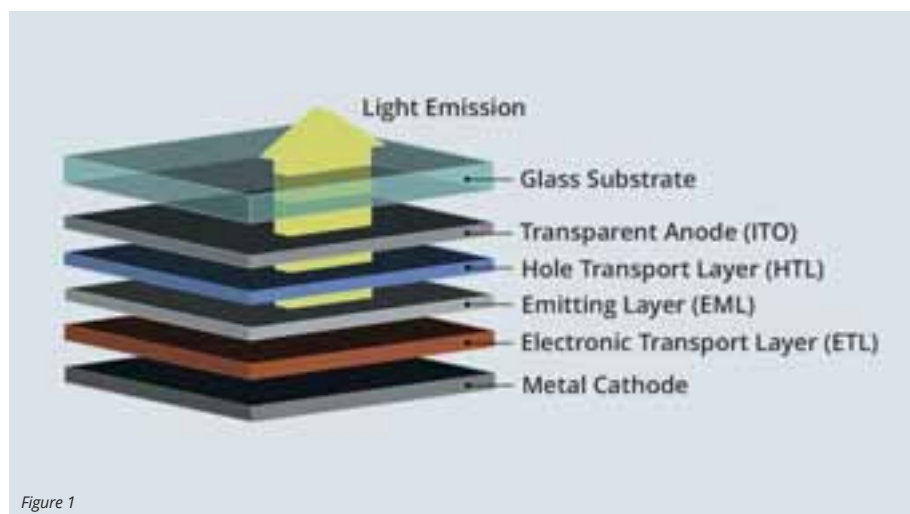

Figure 1

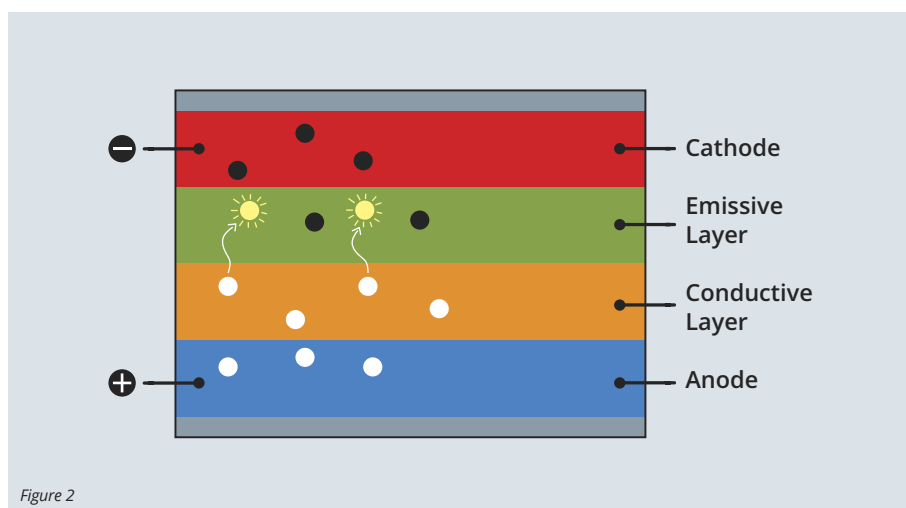

Figure 2

tron) now meets a negative electron, the two charges cancel each other out and emit a short burst of energy. This releases a photon (a light particle) and – light is produced. If the current keeps flowing, holes collide with electrons again and again, continuously generating light. This process is called recombination (Figure 2). In order for the generated light to be visible, at least one of the electrodes must be transparent.

Unlike light-emitting diodes (LEDs), which are a spot light source, OLEDs emit light as an area light source. The light is emitted diffusely and without glare. Each individual pixel emits its own light, this is called self-emitting. This is an essential difference in comparison to a liquid crystal display (LCD), which needs a backlight to make the displayed content visible.

The organic material used in OLEDs consists of carbon compounds. Different compounds determine the colour of the emitted light. So-called small molecules and polymers (large molecules) are used. Almost all OLED displays manufactured today are SM-OLEDs, they use carbon compounds with small molecules (Figure 3). PLED or P-OLED (OLEDs using polymers) have a shorter lifetime and are less efficient than SM-OLEDs. Nevertheless, research is continuing in this direction. It is thought that polymers are easier to process (e.g. by printing) and therefore cheaper displays can be produced in the future. However, this is not the case so far.

AMOLED versus PMOLED

What is the difference between AMOLED (Active-Matrix Organic Light Emitting Diode) and PMOLED (Passive-Matrix Organic Light Emitting Diode) displays?

The basic structure and function of a single OLED has been explained above. Manufacturers place OLEDs with their individual layers on a substrate to create a display.

PMOLED displays are constructed according to a diamond pattern. The anode and cathode are arranged in strips perpendicular to each other. The intersection points between the anode and cathode form the individual pixels from which the light is emitted. The operation of a PMOLED display is simple. Each line of the display is driven sequentially (i.e. one after the other). The individual pixel is selected via the columns. The electronics do not contain a storage capacitor, so the pixels of a row are switched off most of the time. To compensate for this, a higher current is used, which makes the pixels shine brighter. A simple example: if the display has 20 lines, each line that is switched on must shine 20 times as brightly (in practice, the value is not quite as high, but in principle the approach is correct).

AMOLED displays are essentially the same structure and have a complete matrix of anodes and cathodes with organic material in between. In addition, there is a layer of thin-film transistors (TFTs). This technology originates from LCDs and is still used there. The TFT array under the anode controls which pixel is on and at the same time controls the current through the diode. Memory capacitors at each pixel store the individual state of the respective pixel.

In general, AMOLED displays are more efficient than passive matrix displays, because the external circuitry required to operate PMOLED and the driving method consumes more power. They also offer a higher refresh rate, making them more

Tris(8-hydroxyquinoline) aluminum(III)
short: δ -Alq₃ | formula: C₂₇H₁₈AlN₃O₃
emits blue light

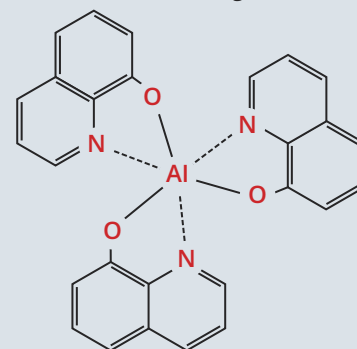

Figure 3

suitable for larger screens such as televisions or monitors.

For the rest of our considerations, we will focus on PMOLED displays. Why not on AMOLED displays, you may ask? Well, for industrial use there are a few essential criteria that are currently not met by AMOLED.

First is the lifetime (by common definition, the time until 50% of the initial brightness is reached). Currently, AMOLED displays have a half to two-thirds shorter lifespan than TFT LCDs. This is due to the organic substances that emit the coloured light. The different colours – red, green, blue – each have a different life span and therefore the colour with the shortest time span must be used as a basis. That is blue with about 20,000 to 30,000 hours. In comparison, a LCD has 50,000 to 70,000 hours, possibly even 100,000 hours.

Secondly, we need to look at long-term availability. AMOLED displays are primarily found in the consumer sector, for example in smartphones, tablets and TV sets. By nature, the market here is fast-moving. Devices are only produced for a short period of time, a few months maybe a year, before the next generation rolls off the production line. Of course, the quantities are correspondingly high, so that this rapid change also pays off economically. For industrial use, the opposite is required – comparatively small quantities and availability for at least 3 to 5 years and in special cases, for example for medical devices, 10 years and often more.

And lastly, AMOLED technology is more complex to manufacture and therefore more expensive than comparable LCDs. Just compare television

sets in both technologies in the electronics market. In the industry, a not insignificant factor.

Characteristics of PMOLED displays

What are the characteristics of PMOLED displays? Let's divide them into groups:

Electrical characteristics

- Low power consumption
- Low voltage
- Wide temperature range

OLED displays are characterised by low power consumption. This is due to the absence of a backlight. In terms of power, PMOLED displays are far below TFT-LCDs and also below monochrome LC displays of comparable size. The voltages required for operation are between 3V and 15V. The semiconductor technology also results in a particularly wide temperature range. This can range from -40°C to 85°C and in some cases even up to 105°C.

Optical features

- Fast response time
- Wide viewing angle
- High contrast
- Suitable for sunlight
- Transparent

The optical advantages are the most striking features. The fast response time in the range of 10µs is much better than that of TFT-LCDs, which is normally a few 10ms. The liquid crystals need a corresponding amount of time to be rotated. The contrast is also much better than with LCDs and is stated to be greater than 10,000:1. This means that the pixels shine against a deep black background. In combination with an appropriate brightness (a luminance of 16lm/W is usually calculated), an excellent picture is created.

The self-luminous pixels also allow an extremely wide viewing angle of 90° from all directions. No shifting of the colours occurs and the image quality is excellent both in a very bright environment and in the dark.

If you also use a glass panel as a substrate, you get a transparent display whose brightness values meet all requirements. This is only possible in this form with light-emitting, i.e. actively illuminating technologies.

Mechanical features

- Thin
- Flexible
- Narrow frame

Technology also plays a role in the mechanical dimensions of OLED displays. The semiconductor layers are extremely thin, which makes it possible to produce very narrow – we are talking about thicknesses of <1.5mm – and lightweight displays. The edge area necessary for the trace routing can also be very narrow. This means that a maximum of active display area is available. If thin plastic is used as the substrate, the display can be made even more thin and at the same time flexible.

Quality features

- Long service life
- Long availability
- Low failure rate

The simple structure of PMOLED displays makes them long-lasting and they are therefore also cost-effective. There are no complex structures, only a few layers are necessary to produce a display. The functionality of this construction results in a long service life and guarantees a low failure rate. In addition, the production in a semiconductor process also guarantees a long availability. However, we do not want to disregard the less good features.

At this point, we must mention the lifetime, which is slightly less than or better than that of a TFT LCD. Due to the properties of organic materials, this depends on many more factors than the LED backlight of a LCD. However, constant improvements are now leading to an acceptable life span that comes close to or meanwhile even exceeds that of a TFT (see Table).

However, it must be noted that for OLED displays, the life time specification refers to a single pixel. If individual pixels are used excessively, they lose brightness more quickly compared to pixels that are used less or not at all. Details on this and tips for countermeasures can be found in the article Display Lifespan from Impulse 1/2022.

Where is the journey heading?

All manufacturers of PMOLED displays are working to improve their products and are also researching new technologies. The reason is that the market for passive matrix OLED displays will

COLOUR	BRIGHTNESS	HOURS
Yellow	120	>80000
	100	>100000
	80	>150000
Green	120	>40000
	100	>50000
	80	>80000
White	100	>50000
	80	>70000
Red	100	>50000
	80	>80000
Blue	100	>20000
	80	>30000

quadruple from today's \$2.5 billion to \$10.5 billion in the next 10 years until 2032. A strong argument for investing in the future. In which areas are the R&D departments working on innovations?

Ease of use

More and more PMOLED displays are being equipped with a touch for ease of use. In the simplest case, this is a projected capacitive touch that is mounted (bonded) to the display, similar to TFT LC displays. This structure is called on-cell touch.

More complex, but also more cost-effective, is an integrated touch functionality. Here, the touch function is built into the display (i.e. a so-called in-cell touch). The display controller also takes care of the touch signals and passes them on to the computer. Currently, however, there are only a few manufacturers who offer combined controllers for display and touch. Especially with small OLED displays, this method is simpler because gestures are used. Multi-touch operation does not make sense in such cases anyway; the area required for this would be larger than the display itself.

Flexibility

What is meant here is mechanical flexibility. As mentioned above, OLED displays can be made mechanically flexible if thin, flexible plastics are used as the carrier material (substrate).

This opens up several new fields of application for the displays. The main area is certainly so-called wearables, i.e. electronics that can be worn, e.g. in the form of a wristband that now also contains a display. The second major area is curved housing surfaces. A bendable display can be adapted to the surface and offers designers completely new possibilities.



©AdobeStock/PavelShaykov

Brightness

However, work is also being done on brighter displays. The so-called TADF (Thermally Activated Delayed Fluorescence) process seems to be a promising approach to more brightness.

On the other hand, the use of TADF materials as emitters or as co-emitters (so-called Hyperfluorescence™) offers other advantages. The OLEDs are not only brighter, but lower voltages can be used, the power consumption is lower than with conventional organic materials and the lifetime is extended. Furthermore, they provide a narrow spectrum, are inexpensive and also free of rare metals. All in all, a positive approach that should soon go into mass production.

Resolution

A constantly recurring topic is also the resolution. Slowly but surely, displays with smaller pixels are entering the market, allowing a higher resolution for the same diagonal. Currently, the pixel density is doubled for standard sizes. With a 2.7" OLED display, the number of pixels increases from 128×64 to 256×128. Graphics can thus be displayed much better.

Miniaturisation

Another trend is moving towards miniaturisation. So-called mini displays are very small, the smallest currently measuring just 0.19", and, depending on the size, currently have a pixel density of up to 846ppi (pixels per inch). Further development is already aiming for 1000ppi. This is considerably more than is offered in the standard sizes. At the same time, depending on the colour, the brightness is increased. For white it starts at 480nits to 700nits, for yellow from 550nits to

1000nits and for green from 800nits to 1600nits, these are remarkable values for these small displays. The next step will be 3000nits for a four-colour display with symbols, but that will probably not be realised before 2025.

Transparency

As mentioned above, it is easy to produce a transparent OLED display. After the first available displays, the development is clearly going in the direction of higher transparency. While the current displays are still >60%, the next generation will have a transparency level of >70% for displays with symbols. In a second step, the transparency will be increased up to >92%. This will be achieved by extremely thin ITO (Indium Tin Oxide) connections, which only slightly influence the light transmission. At the same time, work is being done to increase the brightness to up to 3000nits to ensure good readability.

By combining the features described above, new display variants adapted to special requirements can be produced.

Applications for PMOLED displays

Everyone knows about TVs and mobile phones, but where are PMOLED displays used? The range of applications is almost unlimited. The dis-

plays can be found in:

- **Industry**
in measuring devices, scanners, motor controllers,...
- **Smart Home**
in washing machines, hoovers, air purifiers,...
- **Communication**
in routers, Wi-Fi hotspots, Set-Top-Boxes,...
- **Medical**
in blood glucose meter, blood pressure monitors, toothbrushes,...
- **Automotive**
as head-up display, in tyre pressure gauges, radar detectors, ...
- **Consumer**
in fitness trackers, action cams, smart watches,...

With the current further developments, additional applications are emerging, such as EV charging stations, displays in telescopes, info displays in glasses, electronic locks, laser rangefinders for golfers, etc. A very large variety, which is only rudimentarily reflected above.

A03

▶ Christian Forthuber, +43 1 86305 158
christian.forthuber@codico.com

CONCLUSION

In contrast to AMOLED displays, PMOLED displays are not only found in consumer applications, but have conquered their own markets over time. The predicted quadrupling of the market in the next 10 years shows that the technology is accepted, used and also constantly improved. They offer a whole range of interesting features. So well worth using in a new project?

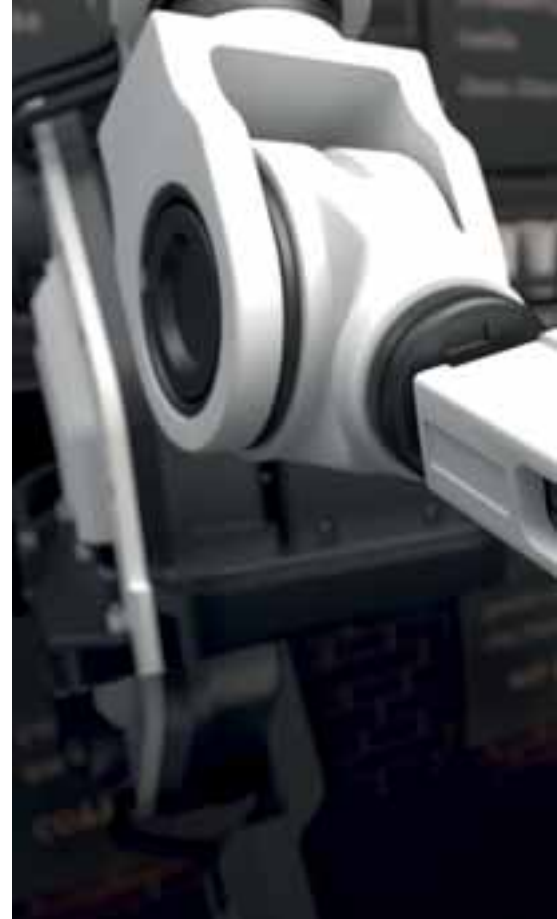

PRECISE

Accuracy and Resolution for Magnetic Angle Sensors

Magnetic position sensors, especially magnetic angle sensors, are the fundamental building blocks of countless motion-control applications that necessitate precision positioning. These sensors are pivotal in a wide range of industries, from automotive and robotics to consumer electronics and medical devices, underscoring their universal appeal and importance (see pictures above).

However, to realize their full potential and utility, one must delve into two crucial parameters that govern their performance: accuracy and resolution. Although these terms are often used interchangeably, they represent distinct – albeit related – concepts in any measuring system. This comprehensive article aims to shed light on these parameters, explain how they impact the performance of magnetic position sensors, and provide guidance on optimizing these factors.

Accuracy and resolution

Within the context of measurement and instrumentation, accuracy refers to the closeness of a measured value to the actual or true value of the quantity being measured. For magnetic position sensors, accuracy is the measure of how precisely the sensor's angle measurement reports the actual angle. Accuracy is a way of understanding how closely the sensor's read position corresponds to the actual position, with a high accuracy sensor producing readings that are very close to the true position.

On the other hand, resolution signifies the smallest change in the measured quantity that a sensor can detect. For magnetic position sensors, resolution is the minimum angle change that the sensor can ascertain. Resolution is essentially a measure of the sensor's sensitivity to minute changes in the position. A high-resolution sensor can detect even the smallest changes in position, providing a detailed, granular measurement. One critical distinction is that a high resolution does not inherently imply high accuracy. A sensor might be highly sensitive to minute changes, meaning it has a high resolution, but it could still be inaccurate if its measurements consistently veer away from the true value. Conversely, a sensor can be highly accurate and consistently provide measurements close to the true position, but it may have low resolution, which means it is unable to catch small changes in position.

This paradox underpins the complexity of designing and implementing magnetic position sensors. Engineers must strike a balance between resolution and accuracy to achieve optimal performance, depending on the specific needs of the application at hand.

Maximizing sensor performance: the tradeoffs

To maximize the performance of a magnetic position sensor system, it is critical for engineers to understand how to quantify accuracy and reso-



©AdobeStock/Es.surawuthi

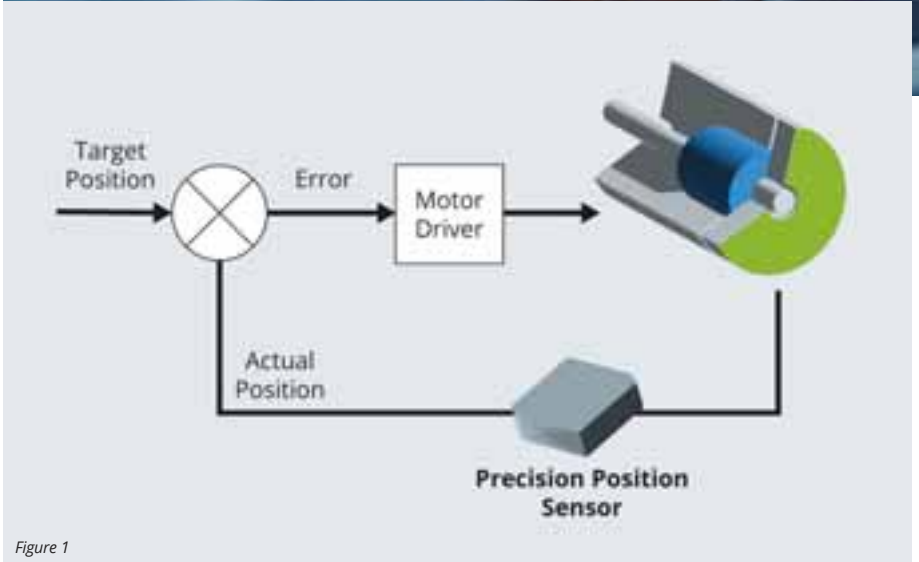

Figure 1

lution. More importantly, they must comprehend what system parameters can be tweaked to enhance accuracy or resolution, and they must understand how manufacturers represent these parameters in their datasheets.

Unfortunately, every improvement or enhancement comes at a cost, and the same applies to increasing resolution and accuracy. Striking the right balance between these two parameters requires careful consideration of various tradeoffs. To enhance resolution, it is important to minimize noise. A window averaging output filter can be used to decrease noise, thus improving resolution. This filter works by smoothing out the random fluctuations in the sensor's readings, helping to deliver more consistent and accurate results.

However, while an averaging filter increases resolution, it lowers the dynamic bandwidth, which means that the system's reactions to accelerations will be delayed proportionally to the bandwidth reduction. If the filter window is set too wide, it can lead to a poor step response and instability in a servo control loop, negatively impacting the system's performance. A basic rule of thumb for Hall-based magnetic angle sensors is that to achieve an extra half bit of resolution, the dynamic bandwidth will be halved.

On the other hand, increasing accuracy (or reducing integral nonlinearity (INL)) can be achieved

through calibration. Calibrating the sensor output after it has been installed in its application can help counteract the effects of mechanical tolerance stack-ups and magnet imperfections, leaving only temperature drift as the primary INL contributor. The tradeoff here, however, is cost. Calibration requires time, resources, and specialized knowledge, which translates into increased production costs. For this reason, calibration might not be a feasible option for all applications, especially those where cost is a significant concern.

In situations where high resolution and high bandwidth are required, or where an extremely low INL is critical (below 0.1°, for example), specific solutions like the MA600 can offer an excellent balance between performance and cost (see Figure 1). The MA600 provides a higher band-

width and resolution than Hall-based solutions, and it is significantly less expensive than the next best alternative, an optical encoder. Because the MA600 is tunneling magneto-resistance (TMR) based, its noise is significantly lower than a Hall-based solution; in addition, the MA600's noise profile is not Gaussian, unlike traditional Hall-sensors. These factors greatly reduce the bandwidth tradeoff in TMR.

Accuracy and resolution quantified

Manufacturer datasheets provide detailed information on not just the sensor's accuracy and resolution specifications, but also other critical parameters, such as the operating temperature range, supply voltage, quiescent current, and magnetic field strength range. Not all datasheets are created equal, however, and one must be careful when comparing specifications.



For example, some manufacturers specify resolution based on a 1σ noise range, meaning that the minimum angle change can be detected only 68% of the time. Meanwhile, MPS specifies resolution as a $\pm 3\sigma$ noise level (see Figure 2). This guarantees that the resolved difference between two angles will be correct 99.7% of the time. Not all manufacturers are so conservative, and it is easy to make the resolution look higher by ignoring the 3σ requirement.

Accuracy (or INL), on the other hand, is relatively straightforward and there is a less leeway to disguise the actual sensor performance. One thing to consider is the temperature range across which the specification is listed. As mentioned previously, calibration can reduce the INL created by mechanical or magnetic tolerances, but it is much more difficult to calibrate against temperature drift.

A04

▼ Thomas Berner, +49 89 1301438 15
thomas.berner@codico.com

Author: Ted Smith, Senior Field Applications Engineer

Gaussian noise

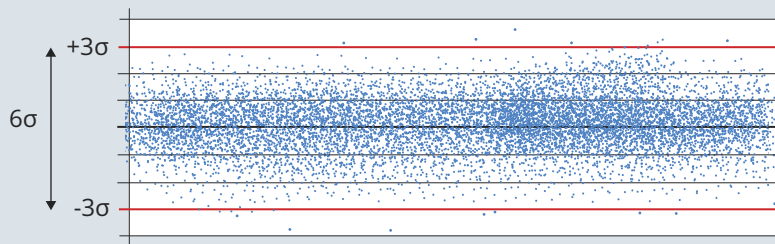

Figure 2

CONCLUSION

Choosing the right magnetic position sensor for a given application involves understanding the intricate tradeoffs between accuracy, resolution, and other system parameters. It also requires an understanding of how these parameters can be optimized to deliver the best possible performance.

By understanding the key concepts of accuracy and resolution and how they apply to magnetic position sensors such as the MA600, engineers can make informed decisions when selecting sensors for their systems. This knowledge helps in optimizing performance, keeping costs under control, and ensuring the successful execution of their designs.

In the ever-evolving world of technology, where precision and accuracy are paramount, understanding the nuances of magnetic position sensors is invaluable. Armed with this knowledge, engineers are better equipped to navigate the complexities of the digital world and harness the full potential of magnetic position sensors in a wide range of applications.

»NEW KIDS« ON »GOLDEN BLOCKS«



The design of PoE Midspan and Endspan Network Switches and injectors has just become easier and more size-efficient with SILVERTEL's launch of the Ag6130-LPB, Power Sourcing Equipment (PSE) module.

The brandnew Ag6130-LPB is a single channel, IEEE802.3.af, .at and .bt* compliant PSE module with the capability of providing signature recognition and power delivery to support PoE, PoE+ and UPoE (proprietary) systems, from 15.4W up to 75W to an Ethernet port.*

Measuring only 21×14×5mm (B×L×H), this device can be deployed in single-port or multi-port systems, squeezing the most out of the available space. The Ag6130-LPB is aimed at applications such as professional AV, media converters, CCTV DVR, home networking, automation and IIoT where ease of implementation, simplicity of use and space-efficient design is essential.

The Ag6130-LPB is a small, surface mount module with golden block terminals, available in trays or tape & reel format for volume manufacture. The interconnect format allows close thermal coupling to the host PCB. Being a high efficiency converter (≥98%), losses are minimised and, with very few additional components required to configure the product, implementation is quick and very straight-forward.

The Ag6130-LPB provides signature recognition and control, essential for a PSE module, allowing for the PoE negotiation process to be initiated

and controlled. The output can be gated via an »Output Disable« feature which allows for disconnection of the output, thereby isolating the PSE module from the connected Powered Device (PD). Reconnection of the module will initiate a restart of the PoE negotiation process.

The module is rated over the industrial temperature range and protected from output overload and output short circuit conditions. The status output is used to determine the connection status of the Ag6130-LPB.

Designed and manufactured in the UK, and fully RoHS compliant, the Ag6130-LPB complements SILVERTEL's extensive range of low cost, compact but highly featured power management modules.

Product and Evaluation board (EvalAg6130) are available from CODICO now to help design engineers make a thorough assessment of the device. Please contact me for further information:

A05

▶ *Andreas Hanausek, +43 1 86305 131*
andreas.hanausek@codico.com

** IEEE802.3bt fully bt compliant up to 30W output*

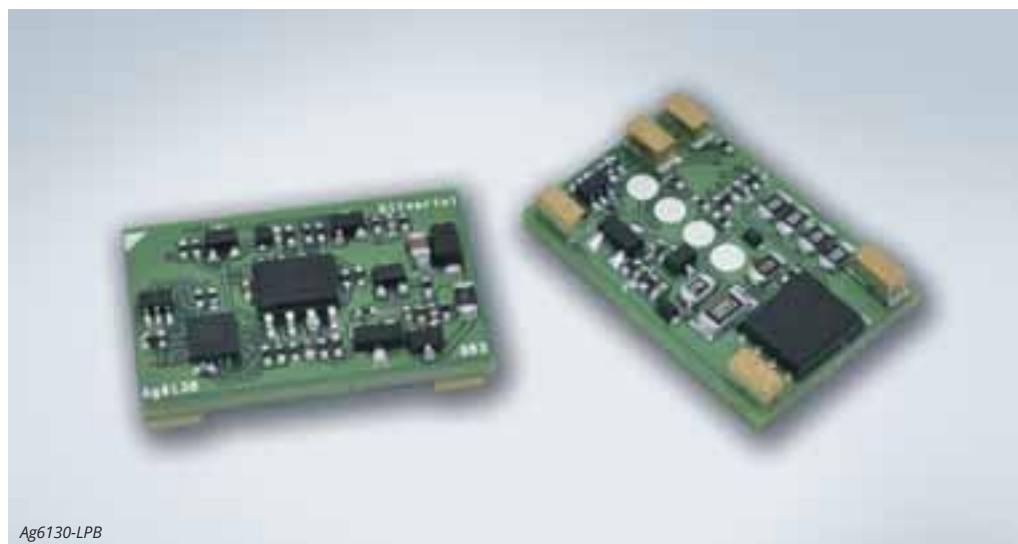

Ag6130-LPB

ALL-IN-ONE-MOTOR

The Next Stage in Highly Integrated Motors

Traditional brushed DC motors are easy to use; simply connect a DC power supply to the terminals and the motor starts running. Adjust the motor's supply voltage and with that adjust its speed, or reverse the supply's polarity to change the motor's direction. Brushed DC motors can easily be controlled and adjusted for each application.

Brushless DC (BLDC) motors when compared to brushed DC motors are the latest step in the electrical motor evolution due to their numerous benefits:

- They run more efficiently
- They need less space
- They run smoother
- They are quieter
- They are more robust
- They have a longer lifetime

However, BLDC motors are not as easy to control as their brushed counterparts, and they require

a level of expertise to operate properly. Apart from a DC power supply, BLDC motors also require a microcontroller (MCU) with software, a power stage, and some kind of angle feedback.

For a BLDC motor to operate correctly, each of the components must interact with each other in a specific sequence. It takes an expert with BLDC control knowledge to complete this task within a reasonable amount of time. If you are not familiar with motor control, you will first have to acquire the necessary expertise before you can control a BLDC motor. In addition to the design, you also have to validate the functions and

test these motors to ensure that they perform reliably.

EZmotion was added to our Linecard to complement CODICO's portfolio for motor-control applications. EZmotion is located in Kirkland, WA, USA and is a total solution provider for high quality servo systems.

CODICO already had motor manufacturers, power stage manufacturers, MOSFET manufacturers, motor control MCU manufacturers, and angle sensor manufacturers in its Linecard, which means that CODICO can now provide a complete motion control system.

EZmotion, our latest addition to our Linecard, goes one step further. They have used their BLDC motor expertise to create a complete system, which is comprised of the following:

- A BLDC motor
- Integrated power electronics
- Integrated control and commutation logic
- Integrated angle feedback
- PC software (GUI)



Figure 1: Fully integrated BLDC Motor





Figure 2: Integrated vs. traditional solutions

This complete system opens the door for simplified operation, enabling even non-BLDC experts to achieve motor-motion control with comparatively little effort.

EZmotion calls their products an all-in-one-motor because everything you need is already integrated. The MMS757xxx family from EZmotion is an integrated servo motor series that can supply up to 188W of power for a wide range of applications.

All-in-one-motors...

- lower the entry level of expertise.
- have a fast time to market.
- provide the latest methods of field-oriented control.
- offer speed, torque and position control.
- are one system for many applications.
- are highly integrated (the lowest volume per watt).
- have high reliability.
- are a flexible system.

All-in-one-motors feature one of the following interfaces:

- I/O (step/direction)
- RS-485 (Modbus)
- CANopen
- EtherCAT

With these interfaces, the motor can be connected to an MCU, PC or some other application controller (e.g. AI).

The quickest path to success is to use EZmotion's MotionLAB software for Windows and the RS-485 interface. After installation, select the model of your all-in-one-motor; all the parameters are loaded on the software automatically.



Figure 3: NEMA 17 and NEMA 23 All-In-One-Motors



Figure 4: MotionLAB > select your motor

If you have a motor product, you are ready to go. However, if you have a module that you are using with your own motor, you will need to align the magnet, which this software is able to do.

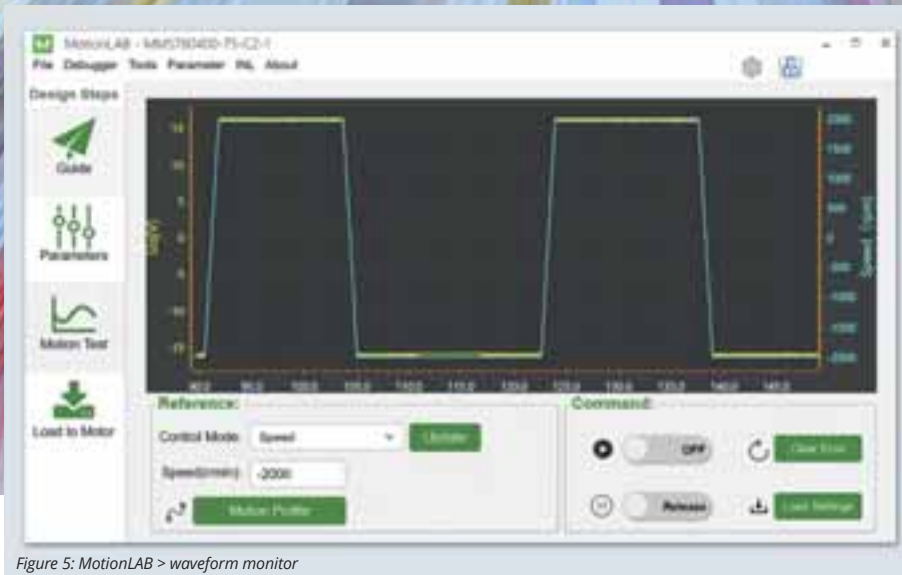
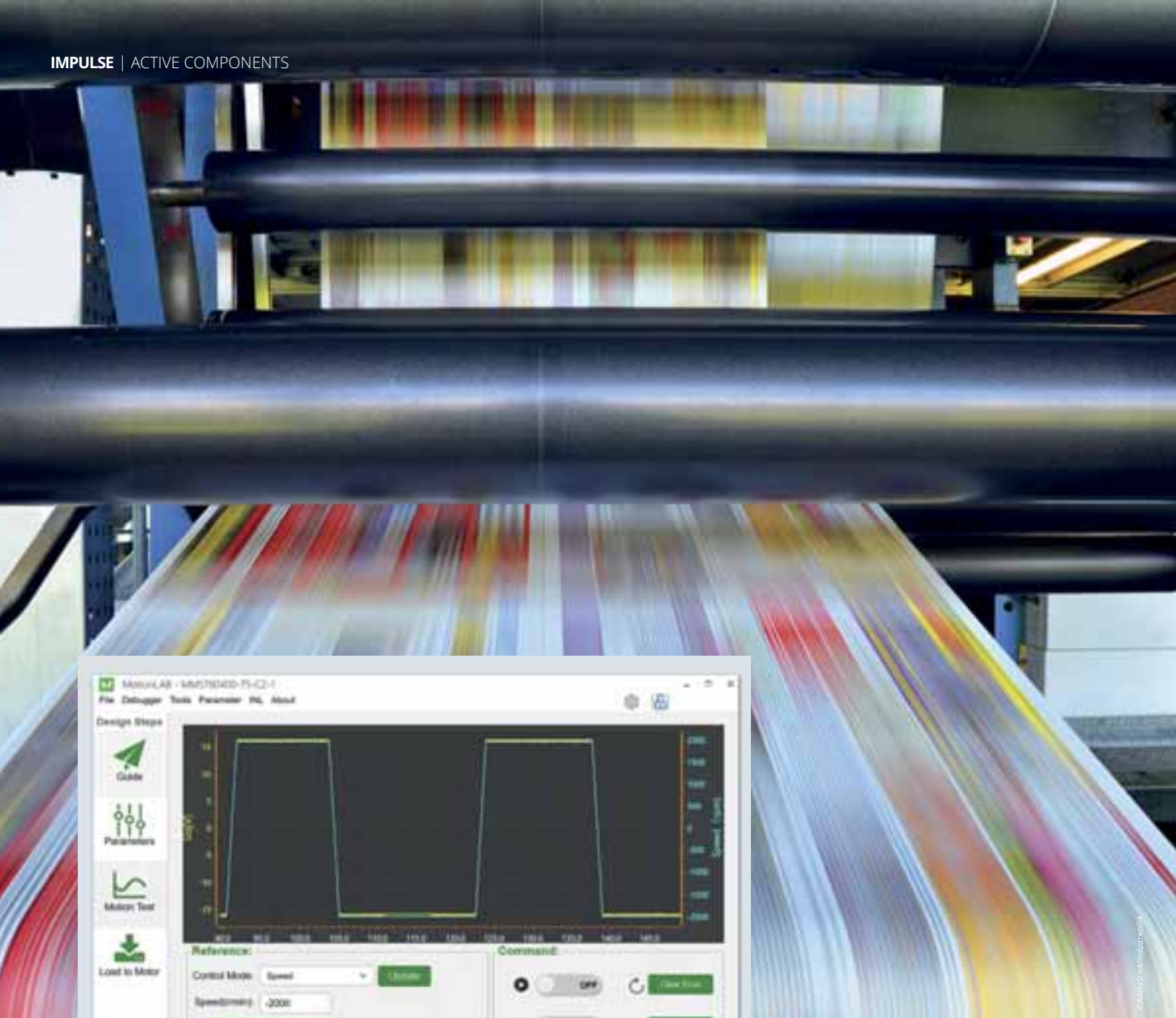

Figure 5: MotionLAB > waveform monitor

When using the software, select either position, speed, or torque control mode, assign the proper value, click update, and enable motor by clicking the »ON« button. The motor sets into motion and is regulated to the set value. You can view motor's behavior on the digital waveform monitor window. From here onwards, you can develop your own motion profiles.

Possible fields of applications for the all-in-one-motors are the following:

- Printing
- Textile machines
- Robotics
- Medical equipment
- Production automation
- CNC machinery

Advantages of EZmotion's all-in-one-motors

- Fully integrated, compact design for space-limited applications such as Robotic Joints and XYZ Positioning Stages
- On-Board Magnetic Position Sensor supports precise position control
- Supports major industrial Field Buses, including RS-485/Modbus, CAN/CANopen, and EtherCAT/CoE
- By supporting Pulse/Direction Control Interfaces, the Servo Motors can replace Stepper Motors without additional modifications to the system
- Provides various Control Modes, including Profile Position (PP), Profile Velocity (PV), Profile Torque (PT), Homing (HM), and more

- Configurable GPIOs for easy use
- Parameter Identification and Loop Auto-Tuning
- Rich Protection Functions, including Over-Current Protection (OCP), Over-Voltage Protection (OVP), Over-Temperature Protection (OTP), Lock, Thermal Monitoring, and more
- AccuFilter and Notch Filter to Lower Noise and Vibration
- Easy to configure via the MotionLAB Virtual Bench GUI Software
- Supports customisation to meet individual application requirements

CODICO can support you in your electric drive endeavors with parts and know how. For further questions, please contact

A06

▶ Klaus Buchenberg, +49 89 130143 819
klaus.buchenberg@codico.com

REM60-W

Miniaturised 60W DC/DC Module Supporting Highest Medical Standards



RECOM has added yet another high density 60W board-mount DC/DC module featuring medical-grade isolation to their portfolio.

The cost-effective REM60-W is available with two input ranges, 9-36VDC, and 18-75VDC, each with a selection of tightly regulated single and dual outputs: 5V, 5.1V, 12V, 15V, 24V \pm 12V, and \pm 15V. The case size of the DC/DC module measures just 2.3x1.5x0.5" (57.9x36.8x12.7mm), achieving industry-leading power density for a 60W part.

Thanks to their excellent efficiency, peaking at over 90%, the DC/DCs operate at 105°C ambient temperature with derating, or to give an example,

to 83°C at full 60W output power with 2m/s air-flow (REM60-4824SW variant).

The REM60-W series has reinforced 2xMOPP isolation, rated 5kVAC/1min for 250VAC working voltage, with creepage and clearance distance from input to output of more than 8mm. Patient leakage current is 4.5 μ A maximum to suit medical B, BF, and even CF (cardia floating) applications.

Medical safety certifications include IEC/EN 60601-1 3rd edition as well as ANSI/AAMI

ES60601-1 and CAN/CSA-C22.2 No. 60601-1:14 for the North American markets. The parts are also compliant with EN 60601-1-2 for EMI immunity for medical equipment. IEC/UL/EN 62368-1 certifications are also held for the IT/multimedia markets and EMC standards EN 55032 Class A and B can be met with a simple external filter.

The REM60-W series is characterised for the operation to 5000m altitude and for a pollution degree 2 (PD2) environment. Reliability is also high at over 1Mhrs MTBF according to MIL-HDBK-217F, 25°C, Ground Benign conditions.

The REM60-W series includes remote On/Off, remote sense, and output voltage trimming with full protection against over-temperature, output overloads, short circuits, and input under-voltage. Operation to zero load is possible, light load efficiency is high, and quiescent and standby current is low. Pin-out is industry standard. RECOM offers a three-year-warranty for this industry leading product. The REM60 strengthens the existing product range of highly reliable and safe REM series available from 1 Watt.

Contact CODICO for information on pricing, lead times and samples.

A07

► *Andreas Hanausek*, +43 1 86305 131
andreas.hanausek@codico.com



REM60-W



LONG LIFE

XCL233: Ultra-Low Power 150mA Buck Micro DC/DC with V_{SET}



Ultra-low quiescent current is important as during sleep mode in most of today's IoT & wearable devices, the supply current of the Power Management IC itself accounts for a major share of the total power consumption. It also has a big impact on battery life therefore, the lower the current the better. In addition, consumers expect their devices to have longer operating time with less frequent charging. The new XCL233 helps to solve both issues.

An efficient step-down circuit can be configured using only 2 external caps as shown in Figure1 below.

The XCL233 also features an enable pin to turn the IC on and off (during stand-by, all circuits are

The XCL233 series is an ultra-low power 150mA PFM step-down synchronous Micro DC/DC converter which has an output voltage select function (V_{SET}) that enables two separate voltages to be pre-selected. Operating voltage range is from 1.8V to 6.0V and quiescent current is only 200nA.

This new ultra-low power buck Micro DC/DC is an ideal solution for powering modern MCUs which can operate over a wide voltage range but when in sleep or suspend mode, only require a relatively low voltage to operate. The XCL233's V_{SET} function supports this and is explained here in more detail.

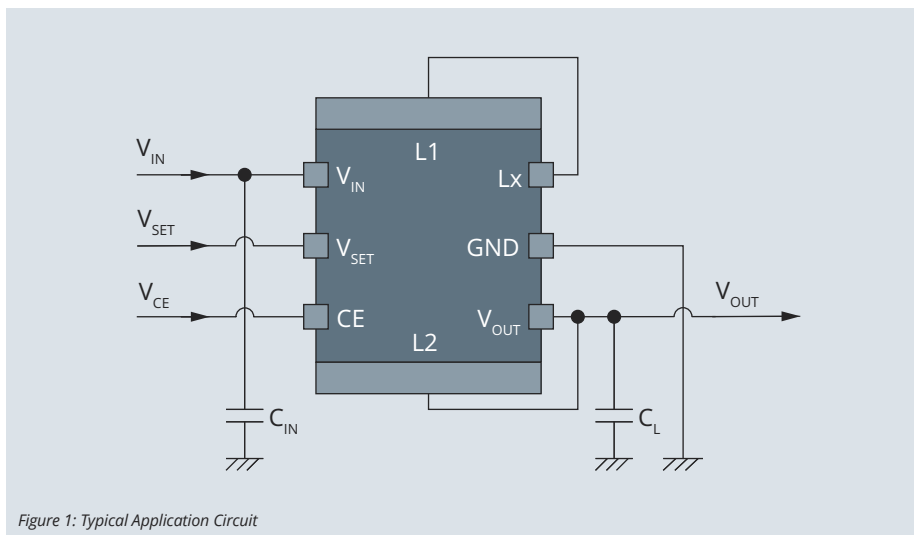

Figure 1: Typical Application Circuit

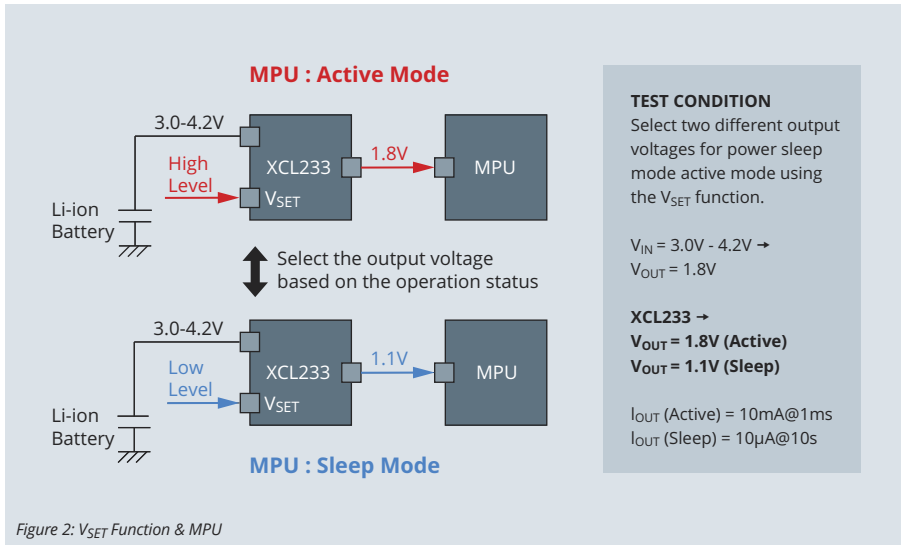

Figure 2: VSET Function & MPU

shutdown to reduce consumption to 0.1µA max.) An optional CL discharge function is also available that can quickly discharge the output capacitor when the IC is turned off and with the built-in UVLO function, the internal P-channel driver FET and N-channel driver FET are turned OFF when input voltage drops below the UVLO detect voltage level.

VSET function

As mentioned, modern MCUs can operate over a wide voltage range but when in sleep mode, the MCU only requires a relatively low voltage to operate. Being able to provide a lower VDD voltage to the MCU during sleep/suspend mode helps to reduce the total current consumption which in turn means longer battery life. The XCL233's VSET function supports this as shown in Figure 2.

As shown above, the VSET pin allows for two pre-set voltages to be selected:

- VOUT1 (lower set voltage for sleep mode)
- VOUT2 (higher set voltage for active mode)

Voltages between 0.6V and 3.6V can be selected for VOUT1 & VOUT2 so, for example, VOUT1 can be set to 1.1V & VOUT2 can be set to 1.8V (as shown in Figure 2 above). The XCL233 is then provided with those two voltages pre-fixed. For operation, a »L« signal to the VSET pin would output 1.1V (for when the MCU is in sleep mode) and a »H« signal would output 1.8V (when the MCU is in active mode).

Any combination of voltages can be provided within the 0.6V~3.6V range.

The benefit of the VSET function is that the optimal voltage can be supplied to the MCU to match the operation status which in turn increases overall system efficiency and extends battery life.

High efficiency at light loads

The 200nA quiescent current also contributes to high efficiency at light-load currents and this makes the XCL232 a solution that really helps to extend battery life in battery powered applications.

This can be seen in Figure 3, the efficiency of the XCL233 at light load currents (within the range of 1µA to 100µA), has tremendously improved when compared to a conventional low power PWM/PFM auto switching buck DC/DC. At 10µA, the efficiency of the XCL233 is still >80%!

Maximise battery life

Based on the test conditions given in Fig. 3 above, compared to a low power LDO (XC6504), a typical low power buck Micro DC/DC (XCL210) will provide 76% more battery life. However, the new

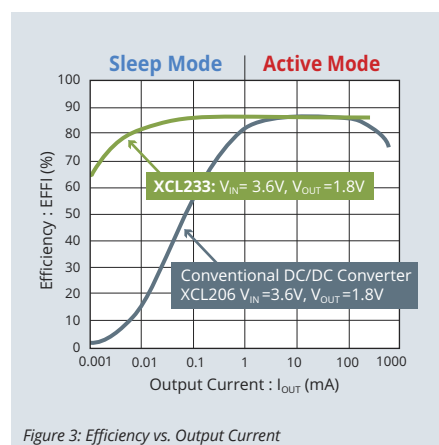

Figure 3: Efficiency vs. Output Current

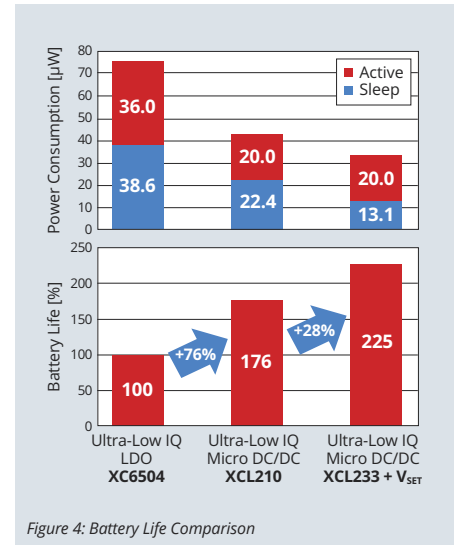

Figure 4: Battery Life Comparison

XCL233 will provide an additional 28% on top of that, meaning that the XCL233 can more than double its battery life when compared to a low power LDO.

The power consumption is also much lower, particularly in sleep mode, where the XCL233 is only consuming 13.1µW, which is nearly half of that consumed by the XCL210 ultra-low power buck Micro DC/DC and around a third of that consumed by the XC6504 ultra-low power LDO (see Figure 4).

Space saving package

The XCL233 series is available in a CL-2025-03 package which measures 2.5x2.0x1.04mm. Refer to Figure 5 for this.

For more information, please contact CODICO.

A08

▶ Johannes Kornfehl, +43 1 86305 149
johannes.kornfehl@codico.com

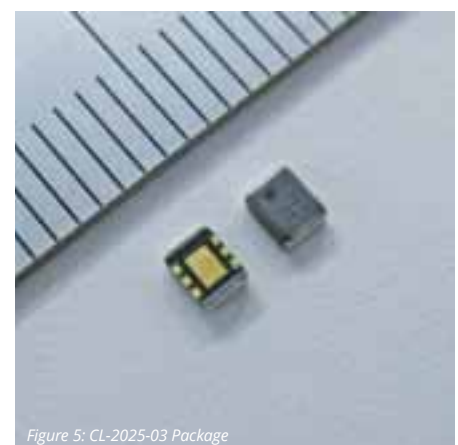

Figure 5: CL-2025-03 Package

THE TARGET – EDGE AI MARKET

SYNAPTICS Multimedia SoCs



Edge AI, empowered by the recent advancements in Artificial Intelligence, is driving significant shifts in today's technology landscape. By enabling computation near the data source, Edge AI enhances responsiveness, boosts security and privacy, promotes scalability, enables distributed computing, and improves cost efficiency.

In recent years, there has been a clear shift of data from centralized cloud data centers to small-scale, local data centers and edge devices that reside close to the data sources. This has led to the emergence and rise of Edge AI. Specifically, the proliferation of data processed at or near the source of data generation has been a key enabler of Edge AI applications in different application sectors.

Nowadays, many enterprises are deploying and using edge functionalities as part of their AI applications. These functionalities enable them to develop energy-efficient, low-latency applications that exhibit real-time performance. Moreover,

Edge AI functionalities provide enterprises with significant security and data protection benefits, which lead to improved privacy control and more effective compliance with applicable regulations. These benefits make Edge AI very appealing to organizations in many different sectors, which deploy and use Edge computing features in a variety of use cases.

This is the reason why the Edge AI market has a growing momentum. According to Fortune Business Insights, the Edge AI market is expected to grow from USD 15.60 billion in 2022 to USD 107.47 billion by 2029 at a Compound Annual Growth Rate (CAGR) of 31.7%.

Industrial & manufacturing

Innovators in the industrial sector see Edge AI and machine learning as vital technologies for their future business prospects. A survey fielded in the spring of 2023 by Arm found that edge computing and machine learning were among the top five technologies that will have the most impact in the coming years. In fact, nearly 70% of the respondents felt that IoT technologies were absolutely necessary for them to compete in their markets.

Industrial modernization and the shift to smart manufacturing have sparked innovations in automation, robotics, and industrial IoT (IIoT). The manufacturing sector has been undergoing a rapid digital transformation based on the introduction of Cyber-Physical Production Systems (CPPS) (e.g., industrial robots, intelligent automation devices) on the shop floor. These systems comprise a physical and a digital part, which enable the

	DVF120	VS640	VS680
CPU	Quad A55 1.9GHz 20K+ DMIPS	Quad A55, 1.8GHz 20K+ DMIPS 2x HiFi4 Audio DSP	Quad A73, 2.1GHz 40K+ DMIPS
GPU	Imagination BXE-2-32, 2PPC Open GL ES 3.2/Vulkan 1.2/OpenCL 3.0 Andriod NN Manhattan 3.0 9.6fps	Imagination GE9608, 2PPC OpenGL ES 3.2/ Vulkan 1.0 Manhattan 3.0 9.2fps	Imagination GE9920, 8PPC OpenGL ES 3.2/ Vulkan 1.0 Manhattan 3.0 20fps
Security	Completely firewall secure CPU , On-chip 32Kbit anti-fuse OTP, Trust zone, TRNG, AES, DES, 3DES, SH1/SHA2/MD5, RSA, ECC	Dedicated SPU, Secure boot, all DRMs , CAS (Nagra, Verimatrix, Irdeto, Synamedia)	Dedicated SPU, Secure boot, all DRMs , CAS (Nagra, Verimatrix, Irdeto, Synamedia)
ML / AI	Up to 30GFLOPS of FP32bit operations in GPU	1 TOPS , includes Synaptics proprietary performance optimizations	6.75 TOPS , includes Synaptics proprietary performance optimizations
Memory	32bit DDR4/DDR3/DDR3L up to 2133MHz	32bit LPDDR4/x, DDR4 up to 3733MHz	32/64bit LPDDR4/x up to 3733MHz
Decoder	Can on CPU	4Kp75 AV1/HEVC/H.264/VP9/VP8	4Kp120 AV1/HEVC/H.264/VP9/VP8
Encoder	Can have external USB based ISP	1080p30 , H.264	1080p120 , H.264, VP8
Display	MIPI-DSI, 24bit RGB	HDMI 2.1, MIPI-DSI, HDR10+, HDR10, HLG, Dolby	HDMI 2.1 (with eARC), MIPI-DSI, HDR10+, HDR10, HLG, Dolby
Camera	USB only	USB only	2x MIPI-CSI / ISP
Video Input	NA	8x TS	8x TS, HDMI 2.1
Audio I/O	In: 4x PDM, 5xI2S (TDM upto 10ch) Out: 5x I2S (TDM up to 10ch)	In: 2x PDM, 8x I2S Out: 8x I2S, SPDIF	In: 4x PDM, 8x I2S, SPDIF Out: 8x I2S, SPDIF
High speed I/O	USB 2.0 & 3.0, SDIO, Gbit Ethernet MAC	Pcle Gen2 single lane , USB 2.0 & 3.0, SDIO, 10/100 Phy	Pcle Gen2 dual lane , USB 2.0 & 3.0, SDIO, RGMII
Tech. & Package	12nm, FCBGA 13x13mm	12nm, FCBGA 13x13mm	12nm, FCBGA 17x17mm

digitization of complex physical processes. CPPS systems collect and analyze data about production processes such as production scheduling, quality inspection, and asset maintenance. Through data analysis, they derive unique insights about how to optimize these processes. Most importantly, they leverage these insights to close the loop to the manufacturing shop floor based on implementing real-time actuation and control functionalities. These functionalities si-

gnificantly improve the efficiency and speed of automation tasks like product assembly and quality control.

Nevertheless, real-time actuation is hardly possible based on cloud data processing, which incurs significant latency. To alleviate the limitations of the cloud for real-time control, manufacturers are increasingly turning to Edge AI. This enables the execution of low-latency machine-

learning functionalities on CPPSs, which makes them suitable for real-time actuation use cases.

SYNAPTICS multimedia SoC solutions

SYNAPTICS' multimedia processors are driving advancements in the smart home. By leveraging the established expertise in high-performance, power-efficient chip designs, the SYNAPTICS' solutions enable an interactive and impressive mul-





© Adobe Stock/Mohammed

timedia experience with seamless connectivity for next-generation AI-based smart home devices.

The VideoSmart™ VS680 solution, an edge computing SoC that combines a CPU, NPU, and GPU. This new multimodal platform with integrated neural network accelerator is purpose built with perceptive intelligence for applications including smart displays, smart cameras, set-top-boxes and media streamers. The SYNAPTICS VS680 is a multimedia powerhouse that combines a Qdeo 4K-video engine, an audio processor capable of far-field keyword detection and voice recognition, and a proprietary SyNap deep-learning accelerator (DLA). It also integrates a higher-performance Imagination PowerVR Series9 GPU. Another new feature is an ISP with HDR capabilities that can handle two 4K cameras. Previous VideoSmart products target the streaming-video set-top-box (STB) market, but the VS680 aims for a broader range of smart-home devices. It's well suited to the Facebook Portal and other smart displays, which enable video calling. The audio processor can drive a smart speaker or sound bar, but when coupled with the DLA, it handles on-device voice-UI functions in addition to providing the front end to a cloud-based digital assistant. The

DLA works with the dual ISP to run neural networks on video streams from front and rear cameras, enabling face ID, object recognition, and security monitoring, among other tasks. The Qdeo engine can drive two displays, allowing the device to power a 1080p touchscreen panel in an STB while simultaneously streaming to a 4K TV. The Neural processing unit achieves 6,75 TOPS for integer 8 operations. The VS640 can still run up to 1TOPS for this accuracy. The other difference to the VS640 is A55 CPU.

SYNAPTICS' VS680 is supported by its SyNAP toolkit which enables customers to optimize ML/AI models to take full advantage of the VS680's capabilities. These models include those for video, vision, and audio AI.

Working with VS680 has been easy and has not required the use of any other designated platform tools which is often a downside when working with special hardware. It's important to note that while some NPUs are »tacked on« to the CPU and GPU in an SoC, the VS680's NPU and AI pipeline are seamlessly embedded so they operate in a trusted execution environment, which is critical for security and privacy.

Application Smart Display

Smart screens have become an exciting innovation platform for consumer, industrial, and enterprise client computing. They started gaining popularity during the COVID 19 pandemic when people started to work from home. By combining artificial intelligence (AI), wireless connectivity, touch, sound, and vision sensing, scalable and secure processing, and advanced display drivers and algorithms, smart screens are capable of fully immersive, context-aware user experiences that are turning them into a multi-functional control points from which to securely interact with a broad range of devices.

A09

▼ Achim Stahl, +49 89 130143 814
achim.stahl@codico.com



WI-FI6 MODULES

FN-LINK Expands its Range



FN-LINK has further expanded its portfolio of Wi-Fi6 module solutions to meet the rapidly growing demand for high data rate Wi-Fi solutions in the robotic, drone, sensor and smart city sectors.

The two new modules, 8266P-PR and 8266M-PU, are based on Qualcomm's brand-new QCA-2066 family of devices, which feature HT160 support, this means a maximum bandwidth of 160 MHz. As a result, the new 8266 family achieves an almost doubling of the maximum data

rate from 1775Mbps to 2976Mbps compared to the 8291 family, which is limited to HT80. Both module families (8266 and 8291) support DBS (Dual Band Simultaneous) on 2.4GHz and 5GHz and are each offered in M.2 and LGA form factors. In addition to the significantly higher data

rate, the new 8266 family already supports the new Bluetooth standard V5.3. A comparison of all features can be found in our table. Data sheets can be found as always on our support page: <http://downloads.codico.com/misc/AEH/FN-Link> Samples are in stock and can be ordered in our sample shop.

A10

▶ André Ehlert, +49 89 130143 811
andre.ehlert@codico.com

MODEL NAME		8291M-PR	8291N-PR	8266P-PR	8266M-PU
ORDERING PART NUMBER		FG8291MPRX-00	FG8291NPRX-00	FG8266PPRX-00	FG8266MPUX-00
					
Platform	Chipset	QCA-6391	QCA-6391	QCA-2066-0	QCA-2066-5
	Interface Wi-Fi	PCIe 2.0, M.2 2230 Key E	PCIe 2.0	Low Power PCIe 3.0	Low Power PCIe 3.0
	Interface Bluetooth	UART, PCM	UART, PCM	UART, PCM	USB, PCM
	Linux & Android / Mainline Driver	yes / no	yes / no	yes / no	yes / no
	Windows	Windows 10	Windows 10	WIN7/WIN10/XP	WIN7/WIN10/XP
Wireless	Bluetooth Standard	V5.1, BLE	V5.1, BLE	V5.3, BLE	V5.3, BLE
	Wi-Fi Standard	Wi-Fi6	Wi-Fi6	Wi-Fi6	Wi-Fi6
	MIMO	MU 2x2	MU 2x2	MU 2x2	MU 2x2
	Frequency	2.4GHz & 5GHz, DBS	2.4GHz & 5GHz, DBS	2.4GHz, 5GHz, 6GHz, DBS	2.4GHz, 5GHz, 6GHz, DBS
	Bandwidth	HT20/HT40/HT80	HT20/HT40/HT80	HT20/HT40/HT80/HT160	HT20/HT40/HT80/HT160
	Antenna Data Rate	1775Mbps	1775Mbps	2976Mbps	2976Mbps
	Monitor Mode	yes	yes	yes	yes
	Antenna Configuration	[BT,2G,5G]+[2G,5G]	[BT,2G,5G]+[2G,5G]	[BT,2G,5G]+[2G,5G]	[BT,2G,5G]+[2G,5G]
	Antenna Type	2x IPEX	2x pins	2x pins	2x IPEX
Module Spec	Power Supply	3.3V	3.3V	3.3V	3.3V
	Dimension (mm)	22x30	19.5x21.5	15x20	22x30
	Package	M.2 2230 Key E module	Small SMT LGA	LGA	M.2
	Temperature Range	-30°C to +75°C	-30°C to +75°C	0°C to +85°C	-20°C to +70°C
	Mounting	double side	single side	single side	single side
	Carrier / QTY	Tray / 30	Tape & Reel / 500	Tape & Reel / 800	Tray / 30
	MOQ	1800	1500	1600	1500
	Weight	2.6g	1.9g	0.8g	2.8g
Certificate	CE, FCC, SRRC	CE, SRRC	CE	upon request	
DVK	no	yes	yes	no	



MEGAWATT

ALTRAN MAGNETICS DC High Voltage Contactors



The world of high voltage DC switching is steadily changing to meet the growing demands of the green energy market. For decades, these markets demanded modest voltages and load carrying capabilities, however we are now seeing standards such as the Megawatt Charging System being discussed and 1,000Vdc power systems becoming the norm.

ALTRAN MAGNETICS DC high power contactors are characterised by:

- Maximum switching capacity in an ultra-compact design
- Safe use in explosive environments
- High switching voltage up to 1,800Vdc
- High current carrying capacity up to 1,000A
- High contact reliability due to stable contact resistance
- Optional AUX contact for safe function monitoring
- Hermetically sealed contact chamber

The engineering team at ALTRAN MAGNETICS has been working hard in the background to take the products that their customers know and love,

such as the AEV250 series, and increase its capabilities and functionality. The traditional AEV250 was designed to switch 900Vdc and carry 500A, with the growing demand from their customer base, last year ALTRAN MAGNETICS started making changes to the existing product to increase its performance. The goal was to keep the form and function of the product the same to prevent customers having costly design changes whilst increasing the switching capability to 1,000Vdc and have full UL approval. With the leading experts in the industry at hand, changes were made to the housing materials, and some internal changes were made that met and exceeded the goal. The result was the new AEV250 »H« version, which stands for High Voltage.

This approach has allowed ALTRAN MAGNETICS to stay ahead of the game and have the broadest offering of high voltage DC contactors in the industry. Another example is a product series named the AEVT1000, this boasts a staggering 1,000A 1,800Vdc switching capability, whilst maintaining a small and lightweight package, this product is perfectly aligned with energy storage systems, commercial vehicle systems and vehicle chargers of the future.

The contact chamber for all ALTRAN products is hermetically sealed, giving engineers the peace of mind that their products will be safe in explosive environments.

In the contact chamber is a blowing magnet and one of the main parts and features of the ALTRAN DC Contactors. Especially, because this has the main function to extinguish the Arc as fast as possible. This also ensures the durability of the product itself.



©AdobeStock/malp

How do the Magnetics Arc Blow-Out Work?

- The permanent magnets create a magnetic field across the contacts, perpendicular to the arc.
- The interaction between the arc current and the magnetic field produces a force, driving the arc outward (perpendicular to both the magnetic flux and the arc current).
- Therefore, stretching and extinguishing the electric arc that is formed as the contacts open to interrupt the current.
- This is the reason for Polarized Terminals.

Furthermore, there are multiple options for coils, from pulse width modulation-controlled economisers, dual coil economisers and a broad offering of input voltages. CODICO and ALTRAN MAGNETICS enjoy working side by side with engineers to support selecting the right product for the individual application. Whether the selection requires customisation, special environmental considerations, or specific testing requirements, working together, a reliable, high-quality solution will be chosen.

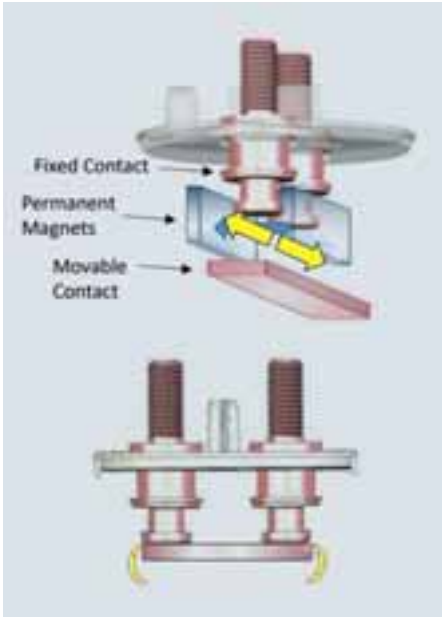

P01

▶ Wolfgang Weiß, +43 1 86305 334
wolfgang.weiss@codico.com

APPLICATIONS

- DC fast Charging Stations
- ESS - Energy Storage Systems
- Battery Packs
- Stationary Energy Applications



©AdobeStock/jamko

RELIABLE OVER-CURRENT PROTECTION



For High-Power Applications: EATONs AMX, AMH and AML Bolt-Down Fuses

Efficient and reliable energy storage is critical in a host of modern applications. Notably, battery technologies have become ubiquitous, owing to several benefits, including low costs, lightweight and compactness, and low self-discharge rates.

Moreover, batteries can store energy produced by renewables to reduce the demand for grid power via peak shaving in peak hours of energy demand. Lithium-ion batteries, for example, provide high-density power, are easy to maintain, and offer thousands of charge cycles over a wide range of operating temperatures. Electric and hybrid-electric vehicles utilize Li-ion batteries as sole energy storage or to augment power from combustion engines. The latest cell chemistries emphasize higher power density in smaller sizes to meet the demand for miniaturisation.

However, this increases the likelihood of damaging fault currents that could result in overheating or internal short circuits during charge. Moreover, there is a risk of »thermal runaway« causing a rapid rise in temperature and pressure within cells.

Due to these limitations, Li-ion battery systems require robust circuit protection to limit the peak voltage as well as maximum charge and discharge currents during operation. Fuses are some of the most common circuit protection elements

designed to limit overcurrent in electronic applications. Fuses are available in a wide range of designs, such as bolt-down fuses (which are well-suited for battery protection).

To meet the needs of high-power energy, industrial, and automotive applications, bolt-down fuses with high interrupt ratings as well as high current, high voltage capabilities are critical. Due to high temperatures and severe conditions typical in higher amperage applications, fuses must perform reliably in a broad range of operating temperatures. Bolt-down fuses must also be sufficiently lightweight and compact for seamless integration into the most space-constrained and component-dense PCBs.

EATON's series AMX, AMH & AML are a family of bolt-down fuses that provide best-in-class power density with nominal current ratings from 350A to 500A. These three product families offer higher voltage ratings, up to 125Vdc, and ultra-high interrupt ratings (up to 20kA). They are suited for overcurrent protection in high-current power distribution applications and against damaging fault currents which may be fueled by the high-power density battery technologies.

They also offer a rejection feature to prevent lower voltage options from being used in place. Applications for EATON's series AMX, AMH & AML fuses include energy, industrial, and transportation.

Features and Benefits

- Bolt-down fuses in industry standard and common footprints
- 125Vdc ratings with high interrupt ratings to support newer battery chemistries
- Fuse holders to accept fuses for easy integration into power distribution systems, are available separately
- Ultra-compact footprints in standard bolt-down configurations
- Can offer different footprint-options that behave like a rejection feature against lower-rated products

P02

▶ Sebastian Gebhart, +43 1 86305 205
sebastian.gebhart@codico.com

APPLICATIONS

- Automotive and commercial vehicle on-board chargers
- On-board electric vehicle powertrain and distribution (eMotorcycles, Forklift, AGV, etc.)
- Mild hybrid automotive
- Motor protection
- Uninterruptible power supplies (UPS)
- Energy storage systems
- All supercapacitor & battery systems
- High current wire protection



MORE POWER



With EATON's new MTA Series

The increasing electrification in the automotive sector and the associated share of power electronics, especially in the DC area, opens up the need for potent inductors more than ever.

Especially for EVs and PHEVs, size and weight have a direct impact on the range of these vehicles. In addition, losses and the resulting heat generation must be kept as low as possible. EATON has taken up these challenges and developed the »MTA« series tailor-made for this purpose.

The MTA series will be available in three different power groups (MTA1V, MTA2V, MTA3V), each offering its own advantages. The MTA1V is the smallest of the bunch. Due to the coin design, it impresses with its low installation height of only 14.3mm (max). It is therefore, suitable for applications where RMS currents of up to 42A and equally little space for the inductor exists.

You will find the MTA2V, in the medium power segment. This is, in contrast to the MTA1V, designed with a flat wire winding in order to minimise DC losses and thus, allow higher RMS currents (up to 80A). The MTA3V is the heavyweight of the series. In the "High Saturation" version RMS current up to 125A and saturation current up to 465A can be expected. All inductors of the MTA series have an iron powder core, with all the known advantages, such as the soft saturation curve, where there is no prompt loss of inductance like it is the case with ferrite core inductors.

In addition, the temperature-dependent saturation drift is almost negligible over the entire operating temperature range. The MTA series is of course AEC-Q200 certified and is therefore suitable for automotive applications. The areas of application are not limited to automotive applications only and range from DC/DC applications with

high current requirements, BLDC control systems and input filtering of inverter systems.

P03

Sebastian Gebhart, +43 1 86305 205
sebastian.gebhart@codico.com

Footnote: The start of series production is scheduled for Q1/2024. All information is preliminary and are subject to change without notice.



	INDUCTANCE [mH]	I _{RMS} (ΔT: 40°C) [A]	I _{SAT} (ΔI: -30%) [A]	DCR (max.) [mΩ]	DIMENSIONS (W×D×H) [mm]
MTA1V2813M	6.8	42	60	2.47	28.6×13.5
	8.2	35	55	2.76	
	10	35	47	2.76	
MTA2V2722L*	2.2	60	90	0.83	26.8×22.8×22.4
	3.5	60	65	0.83	
MTA2V2726H**	3.3	80	128	0.72	27.0×23.0×26.0
	6.8	70	78	0.95	
MTA2V2726L*	3.3	80	100	0.72	27.0×19.0×26.0
	13.0	50	47	2.25	
MTA2V2726M*	4.7	70	95	0.95	27.0×19.0×26.0
	2.2	75	125	0.37	
MTA2V3029L*	3.0	75	102	0.37	30.0×22.0×29.3
	0.82	132	440	0.18	
MTA3V3822H**	2.2	120	205	0.27	38.1×21.9×38.1
	3.3	115	195	0.36	
MTA3V3944S*	1.5	132	205	0.24	38.8×23.8×43.9
	2.2	132	140	0.24	
MTA3V5153H**	2.2	125	465	0.24	50.8×22.0×52.8
	2.8	125	350	0.24	
	3.3	125	320	0.24	

*low loss structure, **high saturation material, Preliminary specification! Values might be adjusted until SOP

FOR SOPHISTICATED DESIGNS

SUN: 16V Hybrid Capacitors



SUN Electronic Industries recently introduced new 16V Al-electrolytic hybrid capacitors in SMD version.

Up until now, if you had lower voltage applications, you had to choose 25V capacitors, in case you wanted to take advantage of the great performance of hybrid capacitors. Of course, with 16V rated you get more capacitance in the same case size. Or you would have to

use pure polymer capacitors, which again have their advantages rather in the lower temperature range.

In DC/DC converters, like buck, boost, or for low voltage BLDC motors, low ESR capacitors are required. If you have high ripple currents to cover, and possibly high temperatures in addition, Al-electrolytic hybrid capacitors are the ideal choice. Additionally, they achieve long guaranteed life time at high temperatures. All in all, hybrid capacitors of the newest generation enable reliable capacitor solutions, that might also help you to achieve miniaturised designs. As those products are AEC-Q200 certified as well, you can use them in your demanding automotive applications.

FVFP series

For a typical 12V line voltage SUN developed their new 16V rated voltage hybrid capacitors. The latest series is FVFP with extremely high ripple current capability. In the size of 10×16.5mm FVFP achieves a rated ripple current of 5,900mA@125°C

with 4,000hrs guaranteed life time and an ESR of 11mΩ. At a rated temperature of 135°C it's still 4,000mA rms. The capacitance in these dimensions is 1,000μF. The smallest size of this series is 8×10.5mm with a capacitance of 330μF and 3,700mA rated ripple current @125°C/2,500mA @135°C (ESR 20mΩ).

FVC series

Another new series is FVC. »C« in the end stands for high capacitance. FVC starts at 560μF in 8×10.5mm, 27mΩ and 3,100mA rms@125°C/1,500mA rms@135°C, both rated with 4,000hrs guaranteed lifetime. In the dimensions of 10×16.5mm SUN achieves 1,800μF with a rated ripple current of 5,200mA@125°C/2,500mA @135°C.

For higher vibration requirements, those series are available with an anti-vibration socket and support soldering-terminals.

If you need samples, further data, or an offer, don't hesitate to contact us!

P04

▶ Roland Trimmel, +43 1 86305 144
roland.trimmel@codico.com





GREEN ENERGY

4-pole AC Charging Relays for Electric Vehicles

SANYOU, a worldwide leading manufacturer of relays, presents SCP40: the new 4-pole mechanically coupled 40A AC charging relay with an auxiliary contact.



SCP40

© Andrius/Alamy

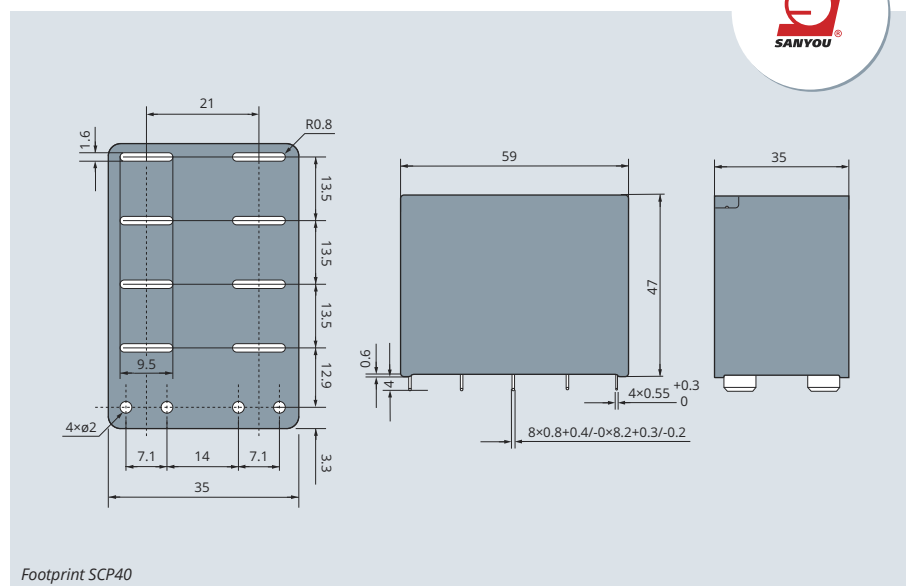

Such electromechanical »new energy« components are designed for a use in electric vehicle charging devices, electric powered devices like cars, trucks, buses, bicycles, boats to name only a few, or any similar applications requiring high loads to be switched and carried.

Key features

- 4 sets of normally open main contacts (40A) + one set of normally closed auxiliary contacts (1A) all mechanically coupled
- When the main contact is bonded, the auxiliary contact meets the safety detection function (according to IEC61810-3)
- Compatible with AC charging stations
- Meets the 3KA short-circuit current test in IEC62955, short circuit capability $I_p \geq 1.85kA$, $I^2t \geq 4.5kA^2s$

- Optimised structure, stronger mechanical impact resistance and lower temperature rise
- Main contact gap 3.9mm
- Weighs only 150g
- Hold voltage can be applied to save power loss

Basic Structure

- Push rod type, 4 sets of contacts

Auxiliary contact and main contact operation IEC61810-3-4.1

- When the SCP40 main contact is closed, the auxiliary contact is in the open state, and the auxiliary contact gap is >0.5mm.
- When the figure shows the energised state, the auxiliary contact is disconnected first, and then the main contact is closed.
- Therefore, the main contact design of SCP40 meets the IEC61810 standard

SCP40 short-circuit test acc. IEC62955

- SCP40 meets the 3KA short-circuit current test acc. IEC62955
- Short circuit performance is strongly influenced by the contact pressure
- The greater the contact pressure, the stronger the short circuit resistance
- SCP40 contact pressure can reach 0,97N

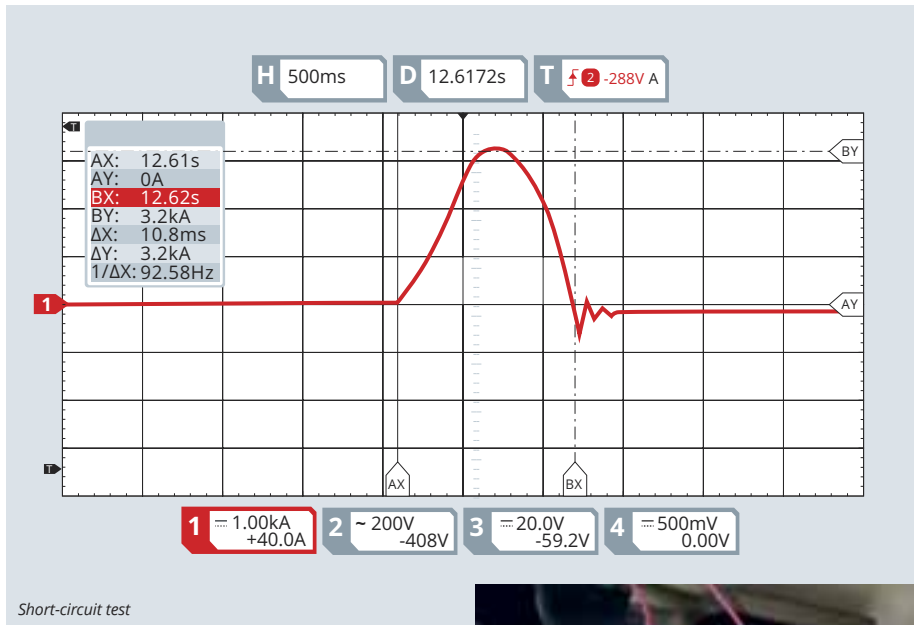

Short-circuit test

Applications

- Relays for Green Energy Applications
- Electric Vehicle Charger applications e.g. Wallbox, Cordset, OBC

Approvals

- UL/TUV/CQC in progress, expected at the beginning of November 2023

Samples available, SOP planned October 2023.

P05

Wolfgang Weiß, +43 1 86305 334
wolfgang.weiss@codico.com

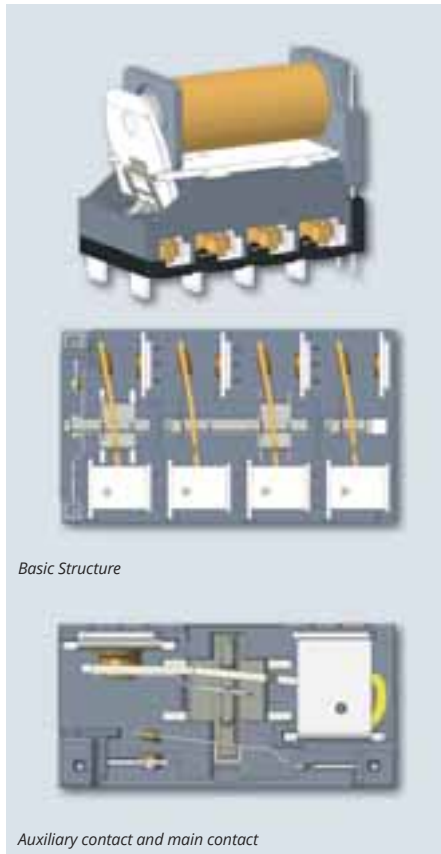

Basic Structure

Auxiliary contact and main contact

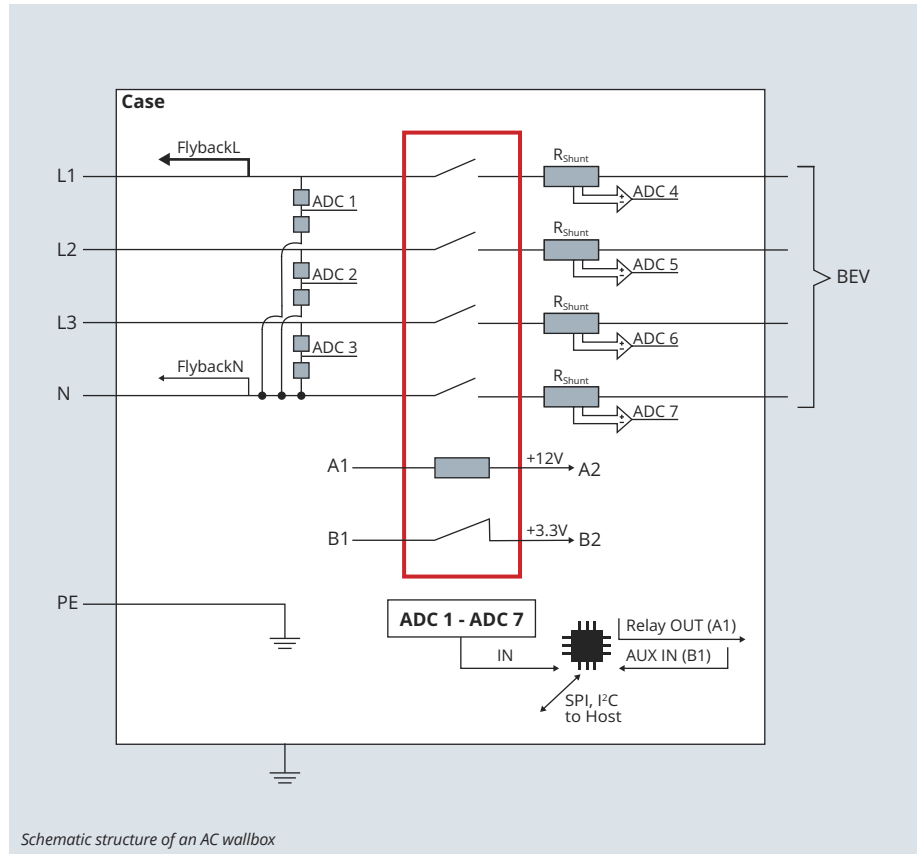

Schematic structure of an AC wallbox



PRECISE CHARGING

Requirements for DC Meters up to 50kW



The IEC 62053-41:2021 standard, published in June 2021, plays an important role in the context of expanding electromobility. It establishes mandatory guidelines for type testing direct current (DC) electricity meters of accuracy classes 0.5 and 1, particularly those used in electric vehicle charging stations or charging infrastructures.

The importance of this standard is the creation of clear specifications and standards for the technology used to measure current in electric vehicle charging systems. This helps to ensure reliability, accuracy and interoperability, which in turn can boost consumer confidence in electromobility. Furthermore, calibration offices also use the IEC 62053-41 to ensure that electricity meters meet the required accuracy standards.

Once the specific requirements are met, the meter is considered »legal for trade« and can be used for billing purposes. Selecting the appropriate measurement technology for the DC meter in a DC charging station depends on various factors, including the specific and relevant application requirements (such as measuring range,

accuracy, and cost) and the environment (electromagnetic interference, temperature).

The following criteria have to be considered:

- How high is the current to be measured?
- What accuracy must be achieved?
- Which standards must be observed?
- Does it conform to calibration law?
- Is a galvanic isolation required?
- How much space is available?
- What is the temperature at the shunt resistor (temperature coefficient)?

Currently, there are two conventional methods in the DC charging station for measuring currents in compliance with calibration regulations. The Hall effect sensor and the shunt resistor. Both

technologies have advantages as well as disadvantages, for this reason it is important to deal well with the selection of the measurement methodology.

Hall Effect Sensor

Advantages:

- Galvanic isolation between the measuring circuit and the electrical circuit to be measured.
- Simple installation and later maintenance, since the sensor can be placed anywhere along
- Little impact on the current to be measured

Disadvantages:

- A precise high-current sensor entails significant costs
- High dependence on temperature (strong drift)
- Bandwidth: The sensor and the line to be measured are coupled via a transformer that has its own frequency response. A shunt resistor is less affected by this problem.
- Magnetic fields: a fixed external magnetic field may cause an offset in the measurement



© Adobe Stock/ADDITIVE STOCK

Shunt Resistor

Advantages:

- High precision in a small size, inexpensive
- Very good long-term stability
- High precision during calibration
- Low tolerances
- Simple implementation

Disadvantages:

- No galvanic isolation
- Power dissipation (can be reduced using very low-ohmic shunts)
- Temperature-sensitive (can be reduced by the low TCR or compensated with the NTC)

A significant advantage of the Hall-based measurement is the simple integration into the application, since Hall-based systems are already isolated by their construction. In comparison, the shunt offers the advantage of a linear measurement over the entire voltage range, while the Hall-based measurement can be considered non-linear, especially in the zero-crossing region. In addition, the shunt has an impressive accuracy

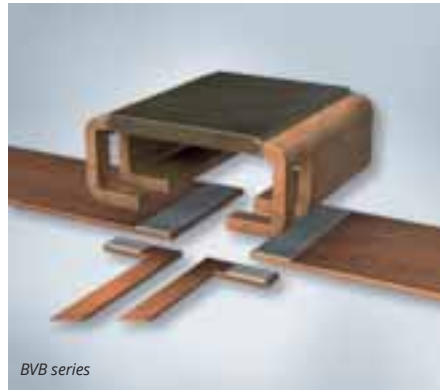

BVB series

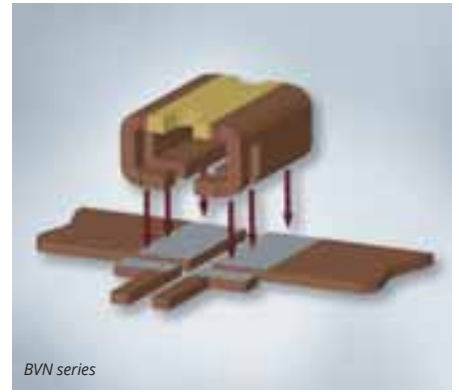

BVN series

of less than 0.5% after a single calibration, while the Hall-based method remains just below 2%.

Our partner ISABELLENHÜTTE is a renowned manufacturer of high-quality precision and power resistors. The company has many years of experience and extensive know-how in producing resistors that meet the highest technical requirements.

Especially the BVB series from the ISA Weld family is suitable for DC current measurement in demanding applications with high accuracy class due to its four-pole terminal connection and excellent long-term stability as well as high precision. The BVB series has a resistance value range of 0.2 to 5mΩ and a rated power of 5W to 12W. Besides the BVB series, the BVN series can also be considered as a possible alternative.

The use of solid copper terminals in these measuring resistors offers several advantages. For one, copper has extremely high electrical conductivity, which ensures even distribution of cur-

rent and heat throughout the resistor. This helps avoid hot spots, areas of elevated temperature that could affect the performance. As a result, these shunt resistors achieve high pulse and continuous load capability. Figure 1 shows the pulse load diagram of the BVB series. It is clear to see that the series can easily withstand a pulse load of 6-700W for 10ms. (Figure 1).

At the same time, the temperature coefficient plays a significant role. The 4-terminal connections minimise the influence of copper and result in a low and stable temperature coefficient. This in turn ensures accurate and reliable measurements over a wide temperature range. The combination of high conductivity, heat dissipation and precise measurement accuracy makes the BVB series a target-oriented solution for DC meters in charging stations up to 50kW, where accurate current measurements and minimal power loss are essential.

P06

► Selma Jakupovic, +43 1 86305 127
selma.jakupovic@codico.com

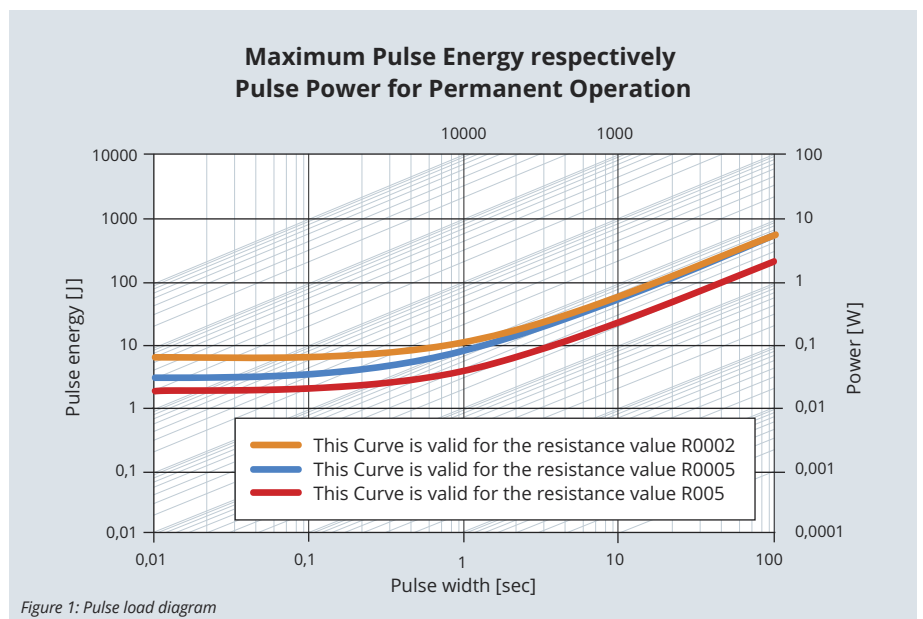

Figure 1: Pulse load diagram

GOOD VIBRATIONS

All your Clock needs can be met by KDS 32.768kHz Products



The frequency of 32.768kHz is widely used in today's world. It is commonly known as RTC (Real Time Clock), which is the oscillation frequency for clocks. The frequency is also used in a low power consumption sub-clock for the sleep mode of MCUs (Micro Control Units). KDS offers several solutions related to this frequency.

Tuning fork crystal

The simplest product would be the tuning fork crystal. It houses a crystal blank with the shape of a tuning fork. Despite its simplicity, this product should be very familiar to you. Whether on walls, wrists or any places, this tuning fork crystal is working in your quartz clocks.

Nowadays, demand for tuning fork crystal like the one found in the sub-clock used in MCU's sleep mode is on the rise. This type shows high resistance values (k Ω unit) at the beginning of the oscillation, which requires more power to start oscillation as compared to the MHz crystal

units. Once it starts oscillating, however, it only consumes very little power. Therefore, it significantly cuts down power consumption as compared to using the main clock's MHz Crystal Unit directly. As energy efficiency is key in the advancing IoT era, the tuning fork crystal supporting sleep modes will become increasingly essential in our world.

Following the packaging trend for crystal products, KDS DST1610A (1.6x1.0mm size) is becoming more popular. Thanks to the photolithography technology for crystal blank processing, the SMD 3.2x1.5mm has established itself as the

most common size today. Due to last year's allocation, smaller sizes with lower material costs are now prioritized.

One of the weaknesses of the tuning fork crystal is the frequency deviation in a wide temperature range. Operation itself is possible even at 125°C, though its parabolic temperature response curve leads to a deviation of more than 400ppm. Therefore, KDS is now offering an oscillator lineup able to achieve a lower frequency deviation.

32.768kHz oscillators

The first concept is a 32.768kHz SPXO, which simply combines a crystal blank and an IC inside one package. KDS offers DSO1612AR, which uses an AT-cut crystal blank instead of a tuning fork crystal blank. Though this IC doesn't have any frequency compensating function, the DSO1612AR is much better at keeping frequency deviation

lower in a wide operating temperature range compared to the tuning fork crystal blank.

The DSO1612AR can maintain a frequency deviation of ± 50 ppm within a temperature range of -40 to +85°C. In the extended range of -45 to +125°C, the deviation is ± 100 ppm, with a slightly higher power consumption of up to 32 μ A during signal output. The oscillator itself has an integrated standby function, which keeps current consumption lower – up to a max. of 5 μ A. Due to these wide temperature range characteristics, DSO1612AR is the first choice as the main time clock for applications like car navigation and car audio systems.

For even higher accuracy requirements, KDS recommends the TCXO DSK1612ATD, which is equipped with an IC for temperature compensation. This temperature compensation capability can maintain a frequency deviation of ± 5 ppm in the range of -40 to 85°C. The DSK1612ATD has a tuning fork crystal blank inside to help keep power consumption low – max 3.5 μ A. This product is used in small wireless communication modules, since the quartz crystal has the lowest jitter level than any other timing device material, including MEMS. With its tight frequency deviation, DSK1612ATD will be an excellent solution for extremely accurate timekeeping.

RTC modules

If you require more than a simple clock function, but also functions like managing log data timestamps, the smallest product is an RTC module, which has the same appearance as the crystal oscillators.

Especially for precise time stamping, a real time clock function is necessary. For instance, in the electronic meters measuring electricity, water, gas, etc., an RTC module is mandatory to prevent tampering. It helps detect when the system was accessed or when attempts were made to interfere with the electronic circuit. Such tampering prevention is also needed for amusement machines.

Time management is also needed in smart home and building automation. Knowing who unlocked the door at midnight or when household appliances are in use will become possible by adding a small electronic device to existing non-electronic equipment (like doors) with low power consumption. These monitoring data will be valuable not just for security, but also from an energy efficiency perspective.

KDS offers two RTC modules with different frequency deviations: DD3225TR (± 11.5 ppm) and DD3225TS (± 5 ppm due to the temperature com-

ensation function). The DD3225TR currently features 10 pins, and the DD3225TS 8 pins. The terminal shape design is flexible because these products are based on KDS's original »Moulding Oscillator« design which allows potential replacements for larger size RTC modules.

As the need for energy-efficient solutions increases, demand for 32.768kHz products will rise as well. If you're interested in trying various 32.768kHz solutions, or have questions about these KDS products, please feel free to call our contact person in your area.

P07

Yasunobu Ikuno, +43 1 86305 276
yasunobu.ikuno@codico.com

SUMMARY

- For tuning fork crystals, DST1610A is the best solution available today.
- SPXO DSO1612AR reaches an overall tolerance of ± 100 ppm
- TCXO DSK1612ATD can reach a tight tolerance of ± 5 ppm
- KDS has two RTC modules: DD3225TR and DD3225TS

KDS PRODUCTS		TYPE	SIZE	TOLERANCE	TOLERANCE CONDITION	MAX. CURRENT CONSUMPTION	VOLTAGE CONDITION
DST1610A		Crystal	1.6x1.0mm	± 20 ppm	at 25°C	-	-
DSO1612AR		SPXO	1.6x1.2mm	± 50 ppm ± 100 ppm	overall at -40 bis +85°C overall at -40 bis +125°C	32 μ A (standby 5.0 μ A)	Vcc=+1.8V to +3.3V
DSK1612ATD		TCXO	1.6x1.2mm	± 5 ppm	overall at -40 bis +85°C	3.5 μ A	Vcc=+1.8V or +3.3V
DD3225TR		RTC Module	3.2x2.5mm	± 11.5 ppm	at 25°C, Vcc= +3,0V	2.8 μ A	Vcc=+3.0V
DD3225TS		RTC Module	3.2x2.5mm	± 5 ppm	overall at -40 bis +85°C	2.8 μ A	Vcc=+3.0V



LET'S DO IT!



© Rubycon/melp

RUBYCON's Engineering Efforts to Shrink Your High-Voltage DC Link Capacitors

DC link capacitors are vital electronic components in power converters. Nowadays, power semiconductors are undergoing changes in terms of material and structure. Engineers need to be careful in choosing the right DC link capacitor on the basis of various characteristics and applications, especially for high-voltage or automotive use. RUBYCON offers reliable solutions in both traditional aluminum electrolytic capacitors and their new PMLCAP technology.

Currently, large film capacitors or large electrolytic capacitors are used as DC link capacitors. The most common choice are electrolytic capacitors, which have high energy density and are cost-effective. However, electrolytic capacitors have limited lifespans and are generally used for voltages less than 1000V.

For applications that don't require as much capacitance as aluminum electrolytic capacitors, film capacitors are an option. Film capacitors have a low equivalent series resistance (ESR) and are able to handle high currents at high frequencies. They also support voltages of over 1000V, levels that electrolytic capacitors cannot cope with.

Both aluminum electrolytic capacitors and film capacitors are used in various applications such as motor drives, solar inverters, uninterruptible power supplies (UPS), industrial and consumer applications, and also increasingly in automotive setups like on-board chargers (OBC).

RUBYCON aims to provide new solutions for both of these types of capacitor technology.

High Voltage PMLCAP

RUBYCON's new PMLCAP technology will be able to replace high-voltage film capacitors in the near future. The characteristics of PMLCAP are as follows:

- PMLCAP stands for **Polymer Multi-Layer CAP**acitor
- No piezoelectric effect causing noise and sound
- No DC voltage bias
- Stable capacitance in a wide temperature range
- No risk of short circuit, smoke or fire
- Today, it is mainly used in high-end audio to replace MLCC
- It is also used for snubber capacitors to replace film capacitors in smaller sizes
- Already over 300 million pcs. have been shipped in the market
- Used widely, including automotive or the NASA Mars lander »InSight«

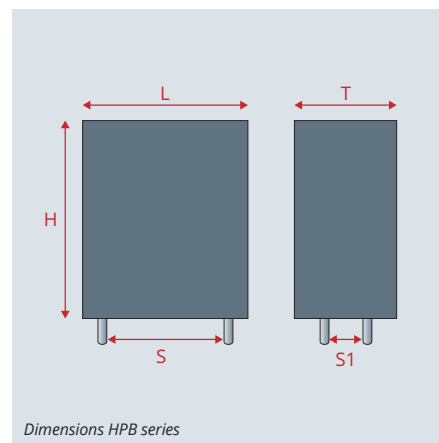
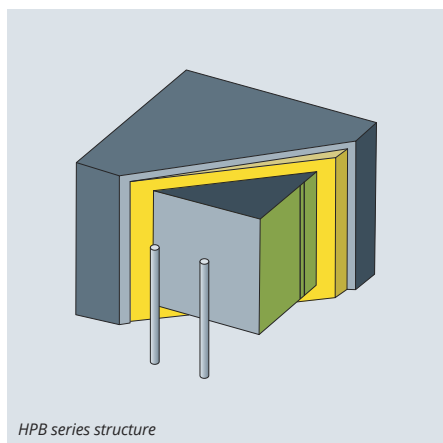

For DC Link usage, RUBYCON offers two series of PMLCAP: the box-type HPB series and the module-type HPM series.

The HPB series specifications include 500-900V and 5-25 μ F, making them suitable as DC-Link capacitors in applications like motor-drive compressors, OBC, and DC/DC converters. When looking at the 900V/20 μ F product, the HPB series can reduce size by 30% compared to today's major 125 $^{\circ}$ C film capacitors, even with today's voltage gradient of 250V/ μ m (volume 56.7cc > 40.1cc). The next target envisaged is to achieve 300V/ μ m, which means that size can be reduced to 55% in the case of the 900V/20 μ F product (volume 56.7cc > 31.5cc). Even when after achieving such a miniaturization advantage, the HPB series can easily withstand 125 $^{\circ}$ C.

The HPM series is intended to replace large-sized film capacitors used in EV inverters. Currently,

we are considering 900V/30 μ F as one capacitor block, and these capacitor blocks can be combined into a module. It may not be widely known in Europe, but RUBYCON also manufactures high-voltage film capacitors. They have a wealth of experience in designing busbar layouts for EV inverters and use this experience now on the HPM series.

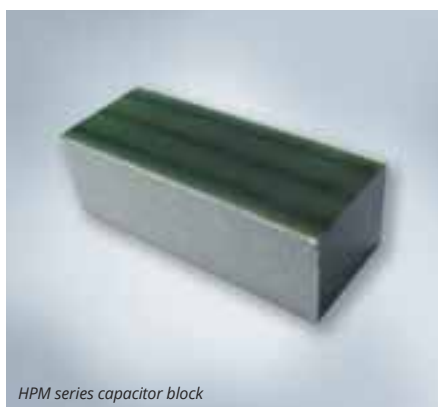

Both series have the following significant advantages over film capacitors:

- Higher heat resistance, which means capability to withstand 125 $^{\circ}$ C or higher.
- Miniaturization reaching nearly half the size of film capacitors currently in the market.

For both series, RUBYCON is planning to increase production quantity in autumn 2023. The technology was recently launched, and we are happy to support your product ideas and opportunities.

New development for electrolytic capacitors

The technology of electrolytic capacitors is generally considered mature, with only a few significant advancements. However, this is not the case for RUBYCON. Over the past few years, the company has continuously developed and introduced groundbreaking new series. Examples include the HXK series, capable of handling high cur-

HPB SERIES SPECIFICATION									
Voltage Gradient [V/ μ F]	Rated Voltage [V]	Cap [μ F]	T [mm]	H [mm]	L [mm]	S [mm]	S1 [mm]	Ir [Arms 10kHz*]	Volume [cc]
250	500	5	12	25	23	18	-	7.7	6.9
		10	18	25	23	18	-	10.9	10.4
		15	23	25	23	18	8	14.4	13.2
		20	29	25	23	18	8	18	16.7
	900	15	29	35	31	26	8	20.5	31.5
		20	37	35	31	26	16	26.1	40.1
25		44	35	31	26	16	30.7	47.7	
300 Coming Soon	900	15	23	35	31	26	8	18.9	25
		20	29	35	31	26	8	23.5	31.5
		25	34	35	31	26	16	27.6	36.9
Competitor's Film Capacitor	900	15	24	44	42	-	-	-	44.4
		20	30	45	42	-	-	-	56.7
		24	33	48	42	-	-	-	66.5



HXX & MXT

rent values of nearly 5A (105°C, 120Hz), and the MXT series, which boasts a maximum capacitance of 1,500µF in a compact 35x60mm form factor. Currently, improvements are focusing on three directions:

1. Higher ripple current with minimal capacitance increase

In the case of capacitors, there is a correlation between capacitance and ripple current. If you adjust the capacitors only based on the ripple current requirement, the capacitance value of the DC-Link capacitor may be unnecessary high. A higher capacitance results in a higher component price, as these are directly proportional to each other. RUBYCON's new technology allows a higher ripple current/capacitance ratio. RUBYCON has the necessary know-how to adjust the electrolytic capacitor to precisely meet your requirements by customising capacitor structure, electrolyte, separator paper, and other factors.

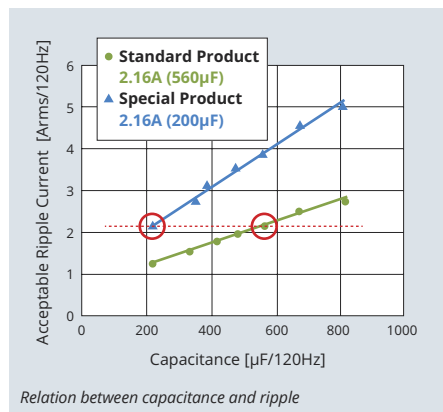

2. Innovative capacitor case structure for water cooling

Until now, electrolytic capacitors were difficult to cool. Due to the safety vent, the capacitor needs some space at the top. This has so far prevented direct contact with a water-cooling plate.

RUBYCON has developed a new package design that allows the capacitor to touch the water-cooling plate without losing the space required for safety venting. This results in lower capacitor temperatures due to water cooling, and in higher ripple current utilization compared to normal conditions.

3. New technology for further miniaturization

RUBYCON is currently developing a new technology that will enable further miniaturization in the near future. Even though their existing series are much smaller than those of other competitors, this new technology will further reduce component size by up to around 15%. As the technology advances further, additional size reductions will be possible.

P08

➤ Yasunobu Ikuno, +43 1 86305 276
yasunobu.ikuno@codico.com

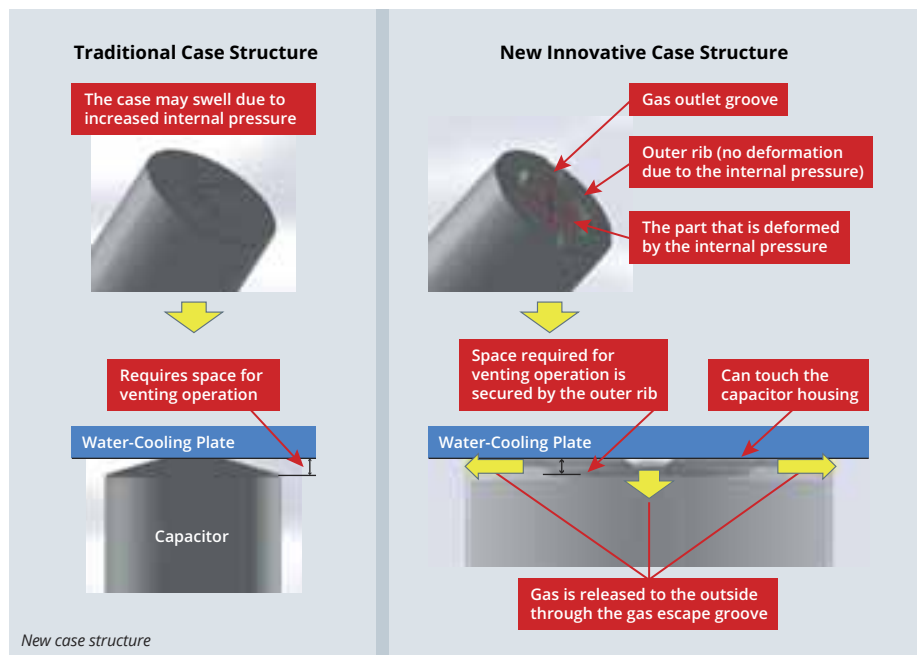

ROBUST

Panasonic
INDUSTRY



High Ripple Current Capability and High Capacitance

AEC-Q200 compliant ZTU series sets new standards for capacitance, ripple current, endurance and temperature tolerance in the compact case sizes of 8×10.2mm and 10×10.2mm. Advancing the performance specifications of the popular ZT and ZC series of electrolytic polymer hybrid capacitors, PANASONIC Industry introduces the new ZTU series with exceptional reliability and ruggedness for any demanding application.

» *The ZTU series is setting new standards with its ripple current and capacitance specs, and reliably guarantees circuit safety at one of the highest temperature ranges currently available on the market,«* points out Hirofumi Maruyama from PANASONIC Industry Europe.

When we have a look into the details of this series, ZTU is a miniaturisation of ZT series. That means a significantly higher capacitance at same dimensions with keeping the same voltage, ESR, ripple current, life time and temperature. Compared to the ZKU series, that is also a miniaturised version in terms of capacitance per voltage and case size, ZTU has additionally lower ESR and higher ripple current capability.

For higher temperature applications ZTU provides an additional specification at 135°C with a guaranteed lifetime of 4000h. Compared to the ZE series this brings the advantage of higher capacitance, lower ESR and higher ripple current per case size.

With all these features, the ZTU series offers the possibility to reduce space requirements, either by using smaller dimensions, or reducing the number of capacitors required in parallel connection.

ZTU is best combination of capacitance/voltage, ripple current and ESR per case size for the dimensions 8×10.2mm and 10×10.2mm and rated temperatures of up to 135°C.

This is highly relevant for a wide range of applications, as Maruyama summarizes: *»As well as many others, it reliably qualifies for being applied in DC/DC or AC/DC inverters, robotics, rectifier circuits and in particular for automotive applications where conditions turn out to be exceptionally severe.«*

Speaking of tough: PANASONIC Industry also offers a vibration-proof version of ZTU capacitors in both 8 and 10mm diameter versions. These are able to handle shocks of up to 30G, while the standard parts also have a vibration tolerance of 10G.

The following table gives an overview of the specifications and a comparison with the series mentioned in this article. If you are interested in samples, further data or an offer, please contact us! You are also welcome to provide us your actual operating conditions with required life time, and we will select the technically and commercially most suitable solution for your application.

P09

▶ Roland Trimmel, +43 1 86305 144
roland.trimmel@codico.com

SERIES	VOLTAGE (V)	CAPACITANCE (µF)	DIMENSIONS (mm)	ESR (mΩ)	RIPPLE CURRENT @125°C / 4000h (mA rms)	RIPPLE CURRENT @135°C / 4000h (mA rms)
ZTU	25	330	8×10.2	22	2900	1800
ZT	25	220	8×10.2	22	2900	-
ZKU	25	330	8×10.2	27	2000	-
ZE	25	220	8×10.2	27	-	1600
ZTU	25	560	10×10.2	16	3500	2200
ZT	25	330	10×10.2	16	3500	-
ZKU	25	560	10×10.2	20	2800	-
ZE	25	330	10×10.2	20	-	2000
ZTU	35	220	8×10.2	22	2900	1800
ZT	35	150	8×10.2	22	2900	-
ZKU	35	220	8×10.2	27	2000	-
ZE	35	150	8×10.2	27	-	1600
ZTU	35	390	10×10.2	16	3500	2200
ZT	35	270	10×10.2	16	3500	-
ZKU	35	390	10×10.2	20	2800	-
ZE	35	270	10×10.2	20	-	2000

MicroSpace™

HIGH VOLTAGE

Solving Design Challenges in Automotive Applications

Amphenol
COMMUNICATIONS SOLUTIONS

In today's rapidly evolving technological landscape, the demand for compact, robust, and versatile connector systems is greater than ever before. The automotive industry is embracing newer technologies such as BMS, camera/sensor and power steering and requires connectors that not only meet stringent performance requirements but also excel in harsh environments.

AMPHENOL'S MicroSpace™ High Voltage selective loaded Crimp-to-Wire connector platform is proving to be a game-changing solution, offering a unique design that combines LV214 Severity-2 compatibility, pitch variations, and high voltage capabilities. This article will explore the outstanding features, benefits, and diverse applications of this exceptional connector system.

Compact design

The MicroSpace™ High Voltage connector platform features a compact design that allows it to fit seamlessly into various applications. With pitch options of 3.81mm, 6.35mm, and 8.89mm,

with 400V, 800V and 1200V capability, this connector system offers flexibility in meeting different space requirements. It also meets LV214 Severity-2 specifications making it ideal for automotive applications.

Keying and Poka-Yoke polarization for visual mismatch prevention

To prevent visual mismatch during assembly and increase overall reliability, the MicroSpace™ High Voltage connectors feature keying mechanisms and Poka-Yoke polarisation. These intelligent design features ensure proper mating and eliminate the risk of incorrect connections, reducing potential errors and increasing productivity.

TPA & CPA

The MicroSpace™ High Voltage connectors feature Terminal Positioning Assurance (TPA) and Connector Positioning Assurance (CPA) mechanisms. TPA ensures the correct insertion and retention of the terminals, while CPA ensures that the connectors are accurately mated and securely locked together. If TPA is not in its final position, it will block against the header interface and will not make electrical contact. CPA can only be actuated when the receptacle is in its final position in the header. These features provide additional confidence in the integrity and performance of the connector system.

Harsh environment suitability and high vibration resistance

MicroSpace™ high voltage connectors are designed to withstand harsh environmental conditions and are built for reliability and durability. With a normal force of 4N for vibration resistance and over 75N for connector locking strength, the

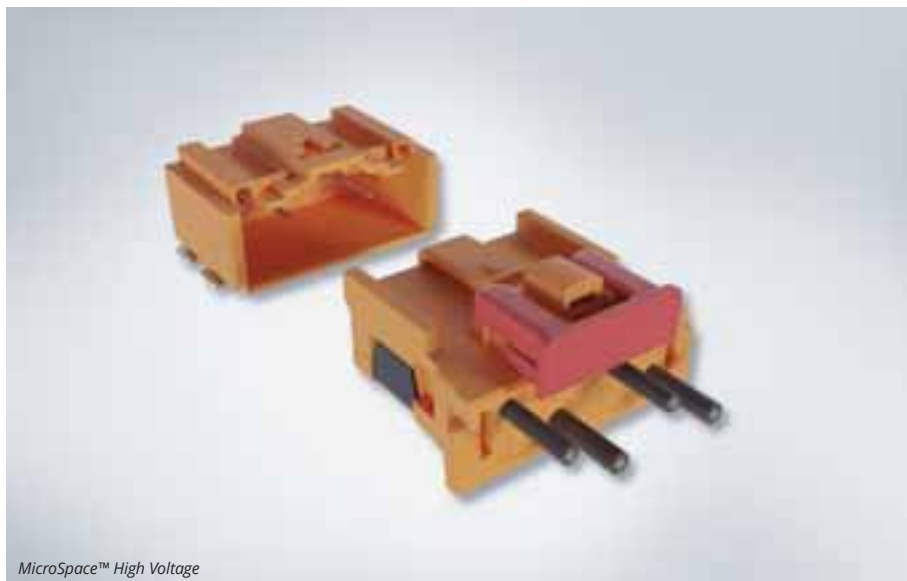

MicroSpace™ High Voltage

se connectors excel in demanding applications with high levels of vibration, ensuring uninterrupted performance even in challenging environments.

Wide range of applications

The versatility of the MicroSpace™ High Voltage connector platform makes it suitable for a wide range of applications. In the automotive industry, these connectors are used in Battery Management Systems (BMS), power steering systems,

cluster/navigation systems, and HVAC units. They are also well suited for camera/sensor systems in various industries.

Ease of installation and use

AMPHENOL's MicroSpace™ High Voltage connectors offer easy installation without the need for specialised industrial tools. The connectors feature a pre-loaded crimp section and automated crimp tooling compatible with 22AWG wires, simplifying the assembly process and reducing time

and cost. For prototyping and first series, AMPHENOL offers easy to use hand tools and pre-crimped leads with a standard cable of 300mm length in receptacle-to-receptacle configurations.

High power performance and current rating

To meet the increasing power demands of modern applications, the connector has a current rating of up to 4A per contact (with all contacts powered). This high current rating ensures reliable power transfer and supports the demanding power requirements of advanced technologies.

In summary, AMPHENOL's MicroSpace™ High Voltage selective loaded Crimp-to-Wire connector platform stands out as an exceptional solution for compact, rugged and versatile applications. With its unique design, LV214 Severity-2 compatibility, keying mechanisms, Terminal Positioning Assurance (TPA), and Connector Positioning Assurance (CPA), this connector system provides a reliable, efficient, and mismatch-free solution.

S01

Julia Reiterer, +43 1 86305 162
julia.reiterer@codico.com

FEATURES

- Pitch: 3.81mm, 6.35mm and 8.89mm
- Voltage Rating: 400V – 800V – 1200V
- Current Rating: 4A
- Dielectric Withstanding Voltage: 1200VAC – 2500VAC – 3600VAC
- Durability: 20 mating cycles for Sn; 100 mating cycles for Au
- Temperature Rise: 30°C max
- Operating Temperature Range: -40°C to +130°C
- LV214 - Severity 2 Compatible

SIMPLER NETWORKS

IEC63171-6 Compliant Sealed Industrial Ethernet Connectors



Single Pair Ethernet (SPE) connectors for industrial applications provide direct Ethernet connectivity to peripheral devices such as sensors, actuators, and vision system cameras operating at speeds up to 1Gb/s. SPE eliminates slow expensive and complex fieldbus protocols and connections by simplifying and standardising existing and new industrial networking systems.

IP67 rated in a round M12 form factor. Rugged right angle and vertical PCB mounting and solder cup SPE receptacles mate with a field-installable plug, providing a complete shielded inter-

face with latching features. Current handling up to 4A supports PoDL (Power over Data Link) capability up to 1km.

- Fully compatible with IEC 63171-6 interconnects from other authorised suppliers ensuring future compatibility and investment security
- Single pair cable reduces cost, weight, and space requirements compared to two and four pair cabling
- Mechanically robust and secure latching with 360° shielding for excellent performance in harsh environments
- Field terminable IDC plugs provide installation flexibility
- IP67 sealing provides protection from water ingress including full immersion in mated conditions
- High strength plastic plug housing and coupling mechanism reduces weight and cost

FEATURES		BENEFITS
Two-way 600MHz data transmission	◀ ▶	Supports ethernet protocols of 1Gb/s up to 40m, and 10Mb/s up to 1km
2 contacts and 2 wire cable for single pair ethernet	◀ ▶	Minimises connector and cabling cost, increases cabling density and ease of installation
4A current rating	◀ ▶	Supports PoDL, up to 1km cable lengths with no signal degradation up to rated data transmission
Panel mount jacks include gasket and mounting nut	◀ ▶	Provides IP67 sealing to mounting panel
360° interior shielding through the mated connectors	◀ ▶	Fully shields signal pair providing excellent EMI immunity
Thermoplastic plug connector housings	◀ ▶	Strong, lightweight assembly reduces cost of cables
Zinc diecast panel jack housing	◀ ▶	High strength and durability with reduced cost
Positive latching with circular push-pull coupling ring	◀ ▶	Prevents accidental unmating
IDC (Insulation Displacement) termination plugs	◀ ▶	Easier field installation and service

S02

Julia Reiterer, +43 1 86305 162
julia.reiterer@codico.com



Series 0256 and 0257

P-LUP



The Best Choice for Uncomplicated Wiring

Modern PCB terminal blocks with levers, such as the 0274 series from DINKLE, have now found their way into the most diverse applications. Among other things, they are an excellent support in the electrification of vehicles and are also frequently used in power supplies and frequency converters.

This is mainly due to the fact that there is no longer any room for screwdrivers in modern terminal wiring. The new design with the operating lever makes the wiring much easier.



Wiring made easy

The advantages of the levers are literally obvious – they can be efficiently operated by hand to connect and also disconnect all wire variants tool-free, including fine-stranded conductors. They allow corrections and improvements to the system anytime and anywhere. Wiring can be carried out easily and safely even in the most confined spaces in the control cabinet.

Pluggable terminal blocks with lever

In the industrial environment, there is often a need for a pluggable terminal block system. In



Series 0256 and 0257

order to allow these to also benefit from the advantages of the lever design, DINKLE has extended its P-LUP range with the 0256 and 0257 series.

Use your existing DINKLE PCB headers in 3.50/3.81mm – or 5/5.08mm pitch and upgrade your system with the 0256 or 0257 Series cable plugs. Optional interlocks with a screw flange or side tab are also available.

DINKLE's 0256 and 0257 series are also compatible with all well-known manufacturers. There is therefore no need to change the PCB layout to make wiring your device faster and easier than ever before.

S03

▶ Christian Sichtar, +43 1 86305 134
christian.sichtar@codico.com

P-LUP Programme



DF51



Wire-to-Board Connector with Locking Function



HIROSE's DF51 series is a robust Wire-to-Board series for applications requiring more strength and durability. A wide range of applications are suitable such as industrial machinery, medical devices, smart meters, industrial robots, and many others.

The DF51 connectors feature a side lock design that allows the connectors to be placed next to each other widthways to save space on the board. The mating operation is user-friendly and a clear tactile click confirms secure engagement and a reliable connection. These connectors feature a strong contact lance strength which increases the contact retention in the housing and prevents the contacts from pulling loose if the cables are wrenched. Furthermore, DF51 is polarised through the use of guide keys to prevent incorrect mating.

DF51 offers many variations for design flexibility. Single or double row versions are available in a

straight, right angle or in-line housing with the option of gold or tin plating. As the demand for reduced wiring is growing HIROSE introduced the Branch Adapter as a new variant. By using the branch adapter, the current is split, helping to reduce wiring in your application.

Wiring has become more complex in industrial equipment with multiple module components, particularly due to the increase in the number of cables used for internal connections. As a result, there is a need to reduce wiring. When branch wiring is used for this purpose, existing branch adapters are often large or soldered, requiring time-consuming wiring.

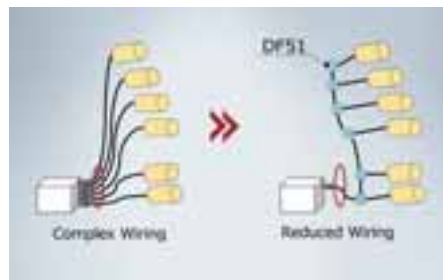

Crimp connection reduces wiring man-hours

To solve this problem, HIROSE has developed a branching adapter for the DF51 series. By mating with a single-row receptacle, the current is split, helping to reduce wiring in the equipment. In addition, the DF51 series uses the same terminals and crimping tools as the long-selling DF11 series board-to-cable connectors, making it easier to complete harnesses. Compatible wire sizes range from 22-30 AWG and are UL/C-UL approved.

Features

- Wide variety to meet different customer requirements: straight/right angle/in-line connection/branch, single/double row, gold/tin plating, etc.
- Side-locking design enables user-friendly operation and reliable connection.
- High contact lance strength prevents the contact from being pulled out when the cable is stripped.

The DF51 series branch adapter will be available in the following versions:

- under mass production: 7 pos. (gold plated)
- planned for development: 2, 3, 4 and 6 pos. (gold plated)

The adapter can be used for multi-axis robot arms, AGVs, AMRs, industrial drones, etc.

S04

Julia Reiterer, +43 1 86305 162
julia.reiterer@codico.com

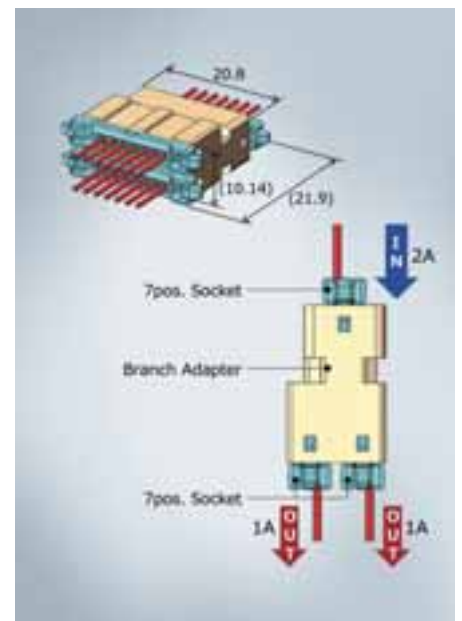

HOT

High Heat and Vibration Resistant Wire-to-Board Connector

HRS HIROSE ELECTRIC EUROPE

As the automotive industry continues to evolve, there is a growing demand for connectors that can withstand harsh environments, high vibration, and extreme temperatures. This is why HIROSE has developed the ZE05 connector series as part of our evolving range of automotive connectors.

The ZE05 is a miniature low profile and rugged connector designed with a 2mm pitch, that allows for maximum space savings on the board, reducing the mounting area required.

The ZE05 series is polarised to ensure correct insertion of the mating half. In addition, the ZE05 series uses tin plating and can withstand temperatures up to 125°C. This heat resistance enables the connector to meet the stringent requirements of the automotive industry.

ZE05 is available with either right angle or straight receptacles for design flexibility. Both receptacles feature surface mount contacts with metal fittings in DIP solder or surface mount to provide strong retention of the connector to the board for high reliability. The receptacles use crimp contacts in sizes AWG20 - AWG22. In addition, the ZE05 housing incorporates an integral rib design that reduces the gap between mated parts, helping to improve vibration isolation to ensure a continuous and reliable connection. Additionally, retainers are available, allowing higher retention forces to be achieved.

Suitable applications include battery management systems, monitoring sensors, engine com-

partment equipment, heavy duty vehicles, electronic control units, on-board charging units, inverters, robotic automation equipment and various automotive electronic control unit communication systems.

S05

▶ Julia Reiterer, +43 1 86305 162
julia.reiterer@codico.com

FEATURES

- Current rating: 5A (one contact)
2A (all contacts)
- Rated voltage: AC 250V
- Contact pitch: 2.0mm
- Operating temperature: -40 to +125°C
- Number of contacts: 2, 4, (single row)
- Number of contacts: 8, 12, 16, 20, 24 (double row)
- Mating cycles: 30
- Cable size: AWG20 - AWG22
- Automotive standard compliant



ZE05

HARDNESS TEST PASSED

Wire-to-Wire Connector with 125°C Heat Resistance

HIROSE has introduced the ZE064W series of wire-to-wire connectors for automotive interface applications.

The innovative design and materials used make the series suitable and reliable in harsh environments. It can withstand temperatures of up to 125°C, meeting the stringent automotive requirements that allow the connector to be placed close to engine compartments. The ZE064W's double-layer, 3-point spring contact design increases contact engagement and ensures contact area stability to withstand high vibration.

The ZE064W is available in wire-to-wire form with compatible cables ranging from AWG20 - AWG22. In addition, both the female and male versions are available in black and grey.

The design complies with IP67/IP69K when mated. The ZE064W is waterproof and can withstand high pressure washing, making it suitable for use as an interface connector for automotive

and industrial applications in harsh environments.

In addition to waterproof protection, the ZE064W series key coding ensures a poka-yoke function when using multiple connectors. Moreover, retainers are available to provide a higher retention force. The embedded retainer design provides a terminal position assurance feature that ensures easy mating and prevents partial insertion of the terminals into the housing.

Suitable applications include battery management systems, monitoring sensors, engine compartment equipment, heavy duty vehicles, electronic control units, on-board charging units, inverters, robotic automation equipment and various automotive electronic control unit communication systems.



Features

- Current rating: 5A (for one contact) 2A (all contacts)
- Rated voltage: AC 250V
- Contact pitch: 2.2mm
- Operating temperature: -40 to +125°C
- Number of contacts: 14, 24
- Mating cycles: 30
- Cable size: AWG20 - AWG22
- Automotive standard compliant

S06

Julia Reiterer, +43 1 86305 162
julia.reiterer@codico.com



ZE064W

NEXT LEVEL

For Battery Management and Cell Contacting Systems



The Y-Lock Pullforce connector system from YAMAICHI Electronics is the reliable and process-safe solution for applications with high requirements, especially for battery management or cell contacting systems in the automotive industry. The system will now be extended by version V4 with Connector Position Assurance (CPA) and integrated contact protection for the FFC/FPC.

The Pullforce System (Non-ZIF) of the Y-Lock features the intelligent One-Push locking mechanism, which is available in different versions. Here, the flexible flat cable (FFC) or the flexible printed circuit board (FPC) is inserted into the connector using the pre-assembled stiffener. In the V3 and V4 versions, the stiffener automatically engages in two steps, first via lateral locking hooks and in the next step via the double front locking.

Blind plugging & contacting possible

Thanks to the guide pins on the system, blind plugging and contacting is also possible. This blind mating is particularly advantageous for applications that are difficult to access or where space is limited. The connection is disconnected by simply pulling out the FFC/FPC – mechanical actuation of the connector is not required.

The Y-Lock version 3 has already successfully established itself in the market. Due to the double locking, the blind mating function and the low profile of 3.9mm, this solution is suitable for battery systems where the FFC/FPC is not under voltage after disconnection from the connector. The Y-Lock system has been qualified based on LV214.

Y-Lock Version 4 with CPA - Connector Position Assurance

The next stage of development is the V4 version. The connector has an optional Connector Position Assurance (CPA) that provides additional locking of the cable side with the connector. The CPA is located on the stiffener side and latches with the connector when actuated. The FFC/FPC can only be released after the CPA has been unlocked. Of course, the V4 also has the front and side locking with Pullforce function, so that secure locking is ensured even without CPA.

Another advantage of Y-Lock V4 is the integrated contact protection in the contact area of the FFC/FPC. This protection ensures that the FFC/FPC is covered by the stiffener from all four sides and that there is no danger if the cable is still under voltage after it has been released.

With V4 the contact distances of e.g., 1.3mm or 1.8mm can be individually adapted to the requirements for clearance and creepage distances.

All versions are available with different pitches and a range of pin counts. Due to the low-profile height of 4.5mm, the Y-Lock V4 is the right choice especially for applications where space is critical.

S07

▶ Christian Sichtar, +43 1 86305 134
christian.sichtar@codico.com

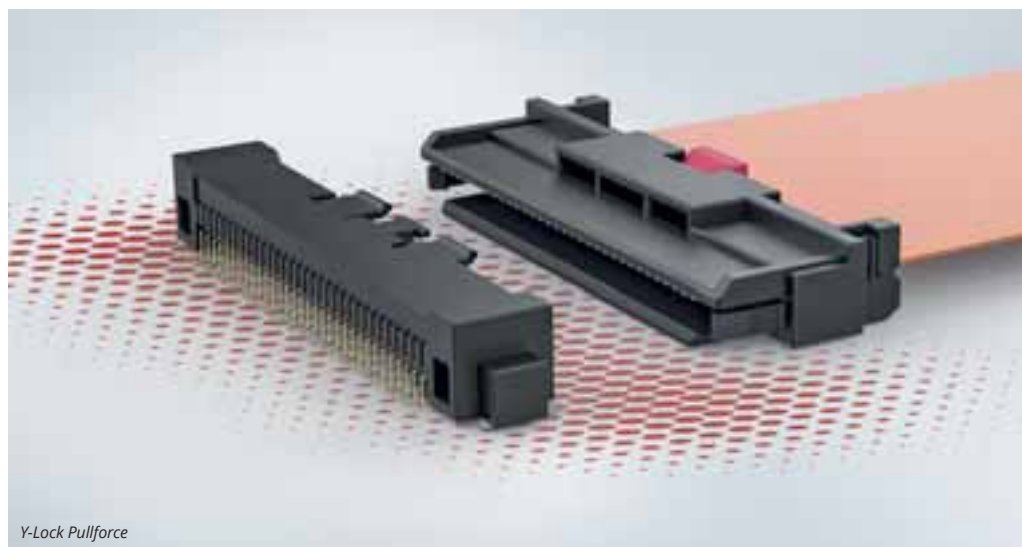

Y-Lock Pullforce

ZERO8 – ZERO LIMITS

In times of increasing miniaturisation, maximum flexibility in electronics design is more in demand than ever. Straight and angled connectors of various heights and with various numbers of pins enable different PCB connections. The Zero8 product group from EPT is regarded as the all-rounder among connectors – and now, to an even greater degree.

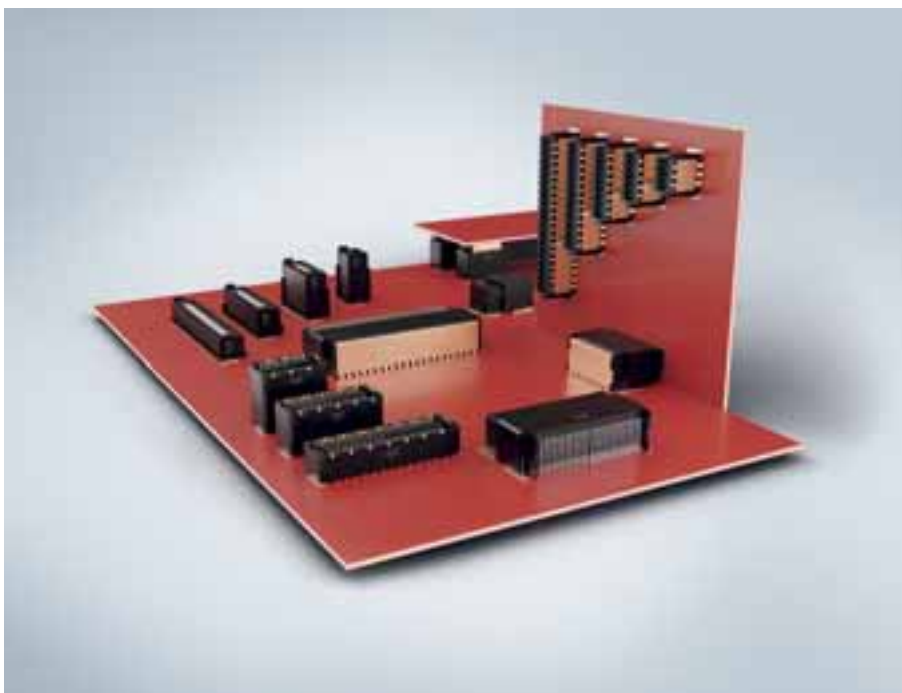

Maximum Flexibility

The four different height profiles of the Zero8 family allow for board-to-board distances between 6 and 21mm. For the developer, the newly added socket height in the high profile now means even more flexibility and the possibility of using the version of this connector with an 0.8mm pitch to make optimal use of installation space. This makes it possible to bridge even larger board-to-board distances, such as those caused by capacitors or inductances in frequency converters. Both connector halves – plug and socket – are currently available as both straight and angled versions, which allows for horizontal, vertical, and mezzanine connections. They are also available with different numbers of pins (from 12 to 80) and thus represent the entire wealth of variants, with all of the connectors being compatible and having the ability to be combined with one another as desired.



©HuberStock/maifram

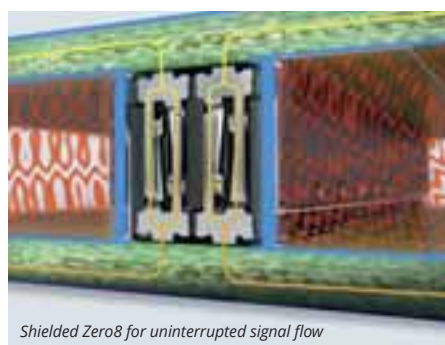

Shielded Zero8 for uninterrupted signal flow

High-Speed without a drop in quality

Simulations run with the connector system also show that all connectors in the Zero8 family have excellent signal integrity and, at 16Gbps, are ideally suited for PCIe 4.0 and Industrial Ethernet. The optional EMC shielding featured in the shielded Zero8 guarantees a high-speed signal flow without a drop in quality.

Miniaturised and robust

Many connectors get damaged during the assembly process due to mistakes such as touching the external contacts or accidentally plugging in the two connector halves the wrong way around.

With the Zero8, damage such as this is out of the question. This is due to various reasons, of which include the internal contacts, which are protected in accordance with the Koshiri principle, and the inclined insertion surfaces at the edge of the insulator material.

The socket and plug can tolerate a mutual displacement of up to 0.4mm during operation. This creates room for play when considering an application's tolerances and makes it possible to place multiple connector pairs on a single PCB without running the risk of experiences losses in contact reliability. In addition, this contact reliability

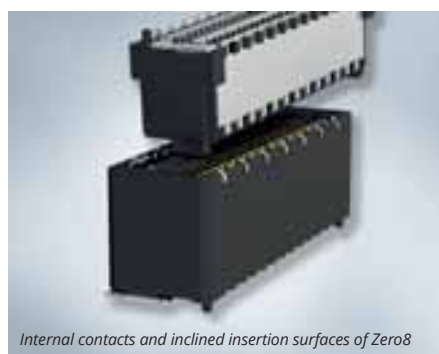

Internal contacts and inclined insertion surfaces of Zero8



Gender-neutral ScaleX connection technology of Zero8

remains stable even in the event of vibration and shock – thanks to the innovative ScaleX connection technology.

Zero8 – zero limits

Anyone who relies on a scalable connector system for their application not only avoids time consuming and costly release cycles, but with the Zero8, they also obtain the maximum degree of variability and thus the maximum degree of freedom in how they design their electronics.

S08

▶ Christian Sichtar, +43 1 86305134
christian.sichtar@codico.com



ENVIRONMENTAL CONTRIBUTION

SINBON's PVC-free Cable Assemblies for Your Choice



People within the cable business know that PVC material plays a huge role in this market. Many manufacturers use PVC (polyvinyl chloride) as the chosen material for the outer covering of wire harnesses because its durability, versatility, and low cost.

However, PVC has been stated as »toxic plastic« by Greenpeace International. The material may release toxins harmful to the human body from the production, application, and disposal stages. In terms of production, the main raw material – vinyl chloride is prone to leakage during the process, which undoubtedly poses a health hazard to factory employees; it is also impossible to recycle the product at the end of its lifecycle, making it an even greater burden for the environment.

With the rising awareness of global environmental protection in the past two decades, regions such as the European Union, North America, Japan, and Korea have not only encouraged enter-

prises to reduce the use of PVC raw materials but also set higher environmental requirements for their products, prompting them to actively develop environmentally friendly products.

PVC-free materials

SINBON has been actively investing in developing PVC free materials to response to the rising awareness of global environmental protection. TPE and TPU are alternative materials for customers' products.

TPE

TPE stands for thermoplastic elastomers. It is a rubber-like material that can be repeatedly stretched without permanently deforming. Due to its

convenient features, including great processability, softness, non-toxic, and recyclability, TPE has largely replaced other types of rubber materials in the automobile sector. TPE is 30% lighter than PVC and is 100% recyclable, unlike PVC, which becomes a waste when it reaches the end of the lifecycle. Besides, since TPE material is easy to process, it can reduce the energy consumption of the machine and also helps to reduce the carbon footprint of the product.

It has a better performance in terms of heat resistance compared to both PVC and TPU, as shown in our table.

TPU

Thermoplastic Polyurethane is known as TPU. It's a form of TPE, however it differs from other TPE materials in that it has improved features like elasticity, resistance to lubricants, and excellent cold and friction resistance. TPU is very flexible and

CHARACTERISTICS		PVC	TPE	TPU
Mechanical properties	Tensile strength (Mpa)	≥10	≥5	≥15
	Elongation (%)	≥100	≥200	≥300
	Flexibility	Good - Excellent	Outstanding	Excellent
Electrical properties	Volume resistance ($\Omega \cdot \text{cm}$ 20°C)	$10^{12} - 10^{15}$	$> 10^{15}$	$> 10^{15}$
	Dielectric strength (Kv/mm)	20-40	10-30	10-30
Operating temperature range		-40 to 105°C	-40 to 125°C	-40 to 105°C
Examples for Applications		Power cables, consumer cables	EV charging cables, EV High-Voltage cables, Automotive ethernet cables, Industrial cables,	Charging cables for robotics, EV charging cables, Wind turbine cables

SINBON has studied PVC-free materials and help customers implement products for over a decade. Corresponding material recommendations are already made in the initial phase of projects. SINBON offers professional wire-drawing services from its raw cable factory, which is equipped with a variety of manufacturing and testing tools.

Aiming to meet the varied demands for customised cable design. SINBON may take advantage of its vertical integration and provide a one-stop shop for everything – from PVC-free raw cable to mass production of the cable assembly itself.

may be colored using a variety of techniques. In contrast to other kinds of thermoplastic elastomers, TPU products have a harder and rougher feel.

Currently, more than 90% of the EV charging cables produced by SINBON are made of PVC-free materials (see Figure1). But also cable assemblies for industrial applications are already PVC

free. For example HIROSE IX cable assemblies produced by SINBON (see Figure 2).

Our way to offer a PVC-free cable assemblies

SINBON, as a provider of bespoke connectivity solutions, has the capability and is prepared to assist our customers in making their product more environmentally friendly.

Please feel free to contact CODICO to receive a quotation for PVC free cable assemblies!

509

Barbara Schanda, +43 1 86305 152
barbara.schanda@codico.com

PVC FREE



Figure 1



Figure 2



BATTERY SWAPPING

An Alternative Refueling Solution for LEV



While the worldwide electrification effort to reduce CO₂ on a global scale is accelerating, the two-wheeled and three-wheeled industry's intention is to expand the usage of a wide range of light electrical vehicle products. To disseminate them, several challenges are to be addressed, such as range extension, shorter charging time, lowering vehicle and infrastructural costs, and better products for improved overall user experiences.

The setup of charging infrastructure along with the growth of Battery Sharing will be key factors to the success of electrification. One

available resource to be leveraged is the charging stations already standardised and rolled out for four-wheeled EV. There are currently 1.8 million

EV charging stations globally as of 2022, with one-third of them being DC fast charging ones, but we still need to grow nine-fold to reach the 15 million units targeted by the International Energy Agency.

This brings up an alternative refueling method – **battery swapping**. The technology may just be the fastest method to recover the power of your vehicle back to 100%. It is driven by many advantages compared with conventional refueling and charging technologies. For one, battery swapping can reduce upfront LEV costs and can address the major drawback of recharging speeds. The technology has also proved to be important for shared LEV applications because it can reduce the environmental impact and operational costs associated with traditional charging strategies. What are the items to be considered when adopting a well-designed swappable interconnect solution?

What first comes to mind is its durability!

Unless your recharge is done on a home charging dock, swappable applications will mostly involve some sort of public sharing. In an application where a single male connector may be mated against several female connectors, manufacturing tolerance and rough usage may significant-



©AdobeStock/arrangendo

©AdobeStock/WESTOCK



Figure 1

ly decrease the life cycle of your swappable connector and further increase the maintenance cost of your product.

For mopeds and light commuting vehicles, swappable batteries are usually located inside of the vehicle compartment or the storage area. When docked, users will not be able to clearly see how to align the battery mechanically and may damage the male connector (which is usually protruded). It is recommended that the interconnect system comes with proper alignment and protection features through mechanical planning on either the connector (in the form of a guide pin), the battery pack, or both. There are two main contact/connector options:

1. Blade Contacts

Some connectors on LEVs may be in a location where it's not possible to have a »straight« mating action to the battery (see Figure 1). This is where Blade contacts are an effective solution (see Figure 2). The biggest advantage of blade contacts is that they can allow a much larger mating angle even if only supported by a small mechanical guiding design. Blade connector solutions also usually have a better cost advantage during the series production phase.

Compared to a Crown/Lamella Spring connector solution (featured later), the Blade contact has a relatively short life cycle and can have more wear resistance to shock/vibration. However, through

experience SINBON has developed techniques to increase the durability of the connection and increase the life cycle. They focus on distributing the contact force and increasing the electrical flow paths in the interconnect system.

Customers can take advantage of SINBON's knowledge gained in this field.

2. Crown or Lamella Spring Contacts

Crown Spring or Lamella contacts are ideal for high current interconnect applications which require high mating cycle counts in a mechanically constrained design space – ideal for Battery Charging (see Figure 3). The electrical performance under shock and vibration is very consistent.

Crown Spring contacts benefit from a multi-contact feature where the contact forces between the male and female connectors are more evenly distributed, and so any plating wear will be significantly reduced which in turn increases the life cycle of the interconnect solution. With SINBON's well-designed solutions, this type of charging contact solution can increase lifetime as well as providing reliable and uniform electrical performance.

Considering where the battery pack is located, there may be different ingress protective requirements for the interconnect system. A vehicle which has a swappable battery located inside of the storage area may only require an IP54 rating as the area will be mechanically sealed, while an application which has the battery exposed to open area may need an IP69K rating (to be cleaned under specific water temperature and



Figure 2: Blade contact



Figure 3: Crown contact



Figure 4

©Alteystrode/Ehning



Figure 5: Symmetrical layout

water pressure). It is better to have a single manufacturer supply the cabling, so that waterproofing of the whole interconnect system can be guaranteed. All of CODICO's & SINBON's swappable interconnect solutions will undergo a full waterproof inspection through an air leakage method before shipments.

A crucial subject for battery safety is heat accumulation.

The connector plays a big role in it. All CODICO & SINBON solutions will complete a heat accumulation study helping the customer understand the temperature rise performance of our design proposal. This ensures that series produced connectors will not overheat and therefore not lead to a serious safety problem. The connector design shall also comply with IPXXB as the minimum requirement protecting against finger access or live parts (apart from solid foreign objects) according to EN IEC 60529.

The connector structure needs to be carefully planned so either all conductive parts are properly insulated, or the mechanical design has the proper clearance and creepage distance for any safety concerns. To minimise arcing, the pin engagement shall be planned so that mating is done in a ground-power-signal sequential.

The last consideration is directional orientation.

A 1kWh swappable battery usually weighs between 6 and 10kg. Ease of use will be a key factor as to how consumers may evaluate the product usage. A swappable battery station tends to be in layers and in racks (so it won't take too much area). See Figure 4. A 10kg battery may be too heavy for some consumers to lift and to turn so it can be charged in a specific orientation. Thus, a bi-directional design may be preferred, with the cost of the interconnect system being a trade-off, as the orientation is achieved through a symmetrical layout (see Figure 5).

CODICO & SINBON solutions have good knowledge of the electrical and electronics and how the battery communicates with the vehicle/charger, so we can work with the BMS (Battery Management System) designer to help the project stay within budget.

Swappable battery interconnection solutions in »Every Day Life«.

Of course, most of our customers are not working on designs of Light Electric Vehicles. However, similar and relatable applications exist in other fields, and indeed in everyday life.

SINBON has worked on many other interconnection solutions for customer's applications that involve Battery and Charging interfaces. Some already involve battery swapping, and others have the potential to move to that approach.

For example, there are very many applications in the Medical and Industrial fields where battery charging is a must, and battery swapping could be a good solution. In general, though, some areas to look for opportunities to use this approach would include:

- Swappable blade connector for high current applications
- Swappable lamella connector for high current applications
- Swappable battery docking solutions (eg. as cradles of end products in warehousing, or other industrial settings)

Whether you need a battery or charging solution, or are looking for an opportunity to introduce Battery Swapping with an experienced partner, then please contact us at CODICO!

S10

▶ Barbara Schanda, +43 1 86305 152
barbara.schanda@codico.com

INAR

IDC RAST Connectors



The connectors of the INAR-IDC RAST series are connection solutions in IDC (insulation displacement technology). They are designed for direct and indirect connection to PCB Boards and tabs.

The focus is on »secure connection«! Four contact points on the insulation displacement connection ensure optimum contacting. Correct and secure mating is achieved through polarisations and various locking options. The cover of the connectors is connected to the housing by a hinge. This allows visual inspection of the connections.

The choice of plastic also focuses on safety – it is GWT 750- 850°C approved. Furthermore, the production of the connectors and the subsequent assembly are 100% controlled by optical systems. For the correct processing of the parts, the entire range of wiring equipment is available from CODICO & INARCA.

Product types

- RAST 2.5
- RAST 2.5 Energy
- RAST 5 TC
- RAST 5 PCB

Approvals and certificates

INARCA products comply with international standards. A list of UL and VDE approvals is available upon request. INARCA is a IATF 16949 Automotiv-certified company.

INARCA

INARCA has been designing and developing terminals, connectors, connection technologies, and machines for electric connections since 1964.

The location in northern Italy enables short transport times within Europe. INARCA supplies leading manufacturers of household appliances, electric motors, drives and automotive components.

All processes are implemented internally by continuous innovation to guarantee the quality of their products and the growth of know-how. INARCA believes in innovation, investing on average more than 10% of their turnover in new products and technologies. INARCA takes care about quality, and they believe that made in Italy means also being able to give quick and competent feedback to their customers. In addition to guaranteeing the quality of what they do, they try to do it while respecting what surrounds them and the people who share their work. INARCA, therefore, works towards achieving excellence in the field of environmental and personal protection, with the objective of continuously improving their performance levels.

The commitment of CODICO & INARCA is always addressed to face and solve their customers' needs to propose solutions and not simple products.

Don't hesitate to send inquiries for INARCA products to CODICO!

S11

► Barbara Schanda, +43 1 86305 152
barbara.schanda@codico.com

Series	Pitch (mm)	Current Capacity (A)	Rated section (mm ²)	Wire direction	Connectable with	Number of ways
Rast 2,5 – fully loaded	2.5	2	0.22 - 0.35	90°	PCB 1.5mm thickness	2-20
Rast 2,5 – selective loaded	5	4	0.22 - 0.35	90°	PCB 1.5mm thickness	2-20
Rast 2,5 Energy	5	6	0.35 - 0.75	90°	PCB 1.5mm thickness	2-12
Rast 5 TC	5	10 16	0.35 - 1.00 1.00 - 1.60	90° & 180°	TAB male terminals 6,3×0,8mm DIN 46244	2-10
Rast 5 PCB	5	6	0.35 - 0.75	90° & 180°	PCB 1.5mm thickness	2-12

RAST 2.5

RAST 2.5 Energy

RAST 5 TC

RAST 5 PCB

TOGETHER ON RECORD COURSE

Vienna Business Run 2023

The Vienna Business Run 2023 is behind us, and at CODICO, there is still a wave of pride and shared memories. This year, we witnessed a record participation of CODICO runners and walkers, achieving outstanding performances.

Over 30 dedicated participants took on the challenge, collectively mastering an impressive 4.3-kilometer course around the picturesque Danube Island. This athletic feat not only highlights the ambition but also the unity of our team.

A glance at the results reveals that Florian Sostek secured the title of the in-house champion with a breathtaking time of 18 minutes and 12 seconds. Following closely was Nils Krumpel, delivering an impressive performance with a time of 18 minutes and 54 seconds. Thomas Podek claimed the third position with a remarkable time of 22 minutes and 16 seconds.

However, the Vienna Business Run is more than just a sporting competition. It is an event that puts the team spirit and unique corporate culture of CODICO in the spotlight. Our runners not only achieved individual best performances but also demonstrated that collective efforts lead to extraordinary results.

The atmosphere along the course was characterized by euphoria and team spirit. Drummers encouraged our teams, while the CODICO flags proudly waved in the wind. The Danube Island provided an impressive backdrop for this sporting event that goes far beyond the actual race.

After the successful finish line, not only did the faces of our participants shine, but there were also well-deserved moments of relaxation and celebration. The Business Run 2023 will be remembered not only as a sporting event but especially as the day when CODICO shone as a team and collectively achieved excellence.

The high number of participants and impressive running times not only highlight our athletic abilities but also the strong unity and determination that characterize CODICO. The Vienna Business Run was more than just a run for us – it was a collective journey where we evolved as a team and grew together. We look optimistically towards future challenges, confident that CODICO will continue to be successful together.

D01

▼ Erhida Nuhi, +43 1 86305 369
 erhida.nuhi@codico.com



QUALITY PAYS OFF



©AdobeStock/Diak

Our TOP suppliers have been receiving the coveted CODICO QUALITY AWARD for more than 10 years. Comparable categories such as delivery reliability, logistics service and sales service are particularly important to us in the selection process.

RECOM is once again one of our TOP suppliers this year. Since the introduction of its first DC/DC converter in 1988, RECOM has created a huge product range for power conversion for all requirements from household to industry. This includes transport, mobility, medical technology, home/office and industrial automation, measuring and testing technology and individual designs by its sister company PCS.

EATON is also one of the best of the best: EATON Electronics combines the know-how of the former Cooper Bussmann Group, which includes the well-known brand names Coiltronics for power inductors, PowerStor for double-layer capacitors and Bussmann for circuit protection. This makes EATON Electronics an excellent all-rounder with a special focus on certified products for the automotive industry. The constantly

growing portfolio offers a wide range of solutions for diverse applications.

The CODICO QUALITY AWARD is a recognition of our suppliers who have best managed to meet the high and diverse requirements of our customers in addition to price and delivery time. Congratulations and many thanks to our suppliers for the excellent performance and the trustful cooperation! Would you like to learn more about our QM system? Please contact

D02

▶ *Petra Landschau, +43 1 863 05 169
petra.landschau@codico.com*



RECOM



EATON

The CODICO TEAM says hello!

Szabolcs Szekely



Travelling! Not only the destination, but also the journey, always being on the move is a joy for me. That has always shaped my life.

During my studies, I worked in the hospitality industry. After 4 years of experience, I had the opportunity to work on cruise ships and so I could combine the useful with the pleasant. My diverse language skills have enabled me to look after passengers from all over the world and get to know many people. After I was able to switch to reception and later to travel organisation, I got the opportunity to get closer to several European countries and their cultures. Austria has always been one of my favourites. The season always lasted from March to the end of November or January. During the 2-3-month winter break, I liked to relax while skiing or in the thermal baths and could recharge my batteries for the coming season.

I also got to know my wife through these trips. At that time, she organised the shore excursions in southern Hungary for our passengers as a travel agency manager. After 4 years of working together, we decided to start a life together in Austria.

At my first job in Austria, I worked for an insurance company serving customers in Eastern and Central Europe. After a few months, I had the opportunity to work as a catering supervisor at Schwechat Airport. This job suited me better, was a lot of fun and very interesting.

In 2015 we started our family and in 2016 our son was born. This had a big influence on my decision to change jobs after 6 years and to look for a more family-friendly job. Therefore, in 2018, I took the opportunity to start as a career changer at CODICO in the warehouse. With the birth of our daughter in 2020, our family happiness was complete.

After five years at CODICO, I am happy to be part of such a great team. I have always liked our company motto: "We live family, we are dynamic and we bear responsibility" and it has always given me additional motivation. The rotation principle that we live by and the variety that comes with it also suits me personally well, as I am always ready to learn something new. I look forward to many more years at CODICO.

D03

▼ Szabolcs Szekely, +43 1 86305 321
szabolcs.szekely@codico.com



Mathias Gager

It gives me great pleasure to introduce myself to you in my 5th CODICO year. My name is Mathias Gager, I am 38 years old and part of the CODICO IT team. When I joined CODICO, I was able to combine my school roots with my professional specialisation. After graduating from the HTL-Mödling electronics department, I completed the part-time degree programs in industrial engineering (Bachelor) and process management (Master). A project management certification completed my specialisation in IT project management for the time being. Since almost every internal process change also involves the adaptation of software, I ended up in IT.

As part of a great IT team, I am responsible for the implementation of IT and digitalisation projects. This includes, for example, the implementation of IT systems and the connection of customers and suppliers via the electronic data exchange EDI. In addition to the project business, the further development and maintenance of IT applications is also part of my job.

What do I like most about my work? In short, the diversity of my work. From the development of specifications to implementation, I get to accompany the entire process. Of course, this also includes the close cooperation and exchange with various specialist groups and external service providers, which is very important to me and contributes significantly to the ideal solution. Now a few sentences about my private life:

Together with my wife, I live near the CODICO headquarters south of Vienna, in Brunn am Gebirge. In my free time I try to stay active with a varied mix of sports, including hiking, beach volleyball, basketball, sailing, archery, yoga, motorcycling and road cycling, and in winter cross-country skiing and skiing. My great passion, however, is Judo. I have been practicing this martial art since I was 11 years old, I am a 2nd degree black belt holder and have competed in numerous national and international competitions in the past. I retired from competitive sports a few years ago and have since been involved mainly as a coach in the club. Of course, I am still on the mat as a hobby.

Apart from the opportunity to help shape processes and work out solutions on my own responsibility, what I particularly appreciate about CODICO is the collegial and respectful way of dealing with each other, which is also reflected in the many benefits.

I am proud to be part of the CODICO team and look forward to future professional challenges and good cooperation.

D04

▼ Mathias Gager, +43 1 86305 215
mathias.gager@codico.com

Denis Barranco



Dear Impulse readers, it is my pleasure today to take some minutes to introduce myself. I have been part of the CODICO family for more than four years now and it has been a wonderful journey so far.

I am a Field sales engineer for CODICO based in France in Aubagne. I am in charge of sales for the active components in the »South« of France which is indeed the best half of France. You can find the Mediterranean Sea, the Atlantic Ocean, the Alps, the Pyrenees and many other amazing places.

I have lived here (near Marseille) all my Childhood, and left for my studies at the age of 20. I spent three years in engineering school in Paris – which is also an amazing city with many things to do – and started my professional life around Paris for a total of five years living there. This open position at CODICO allowed me to move back to my hometown when I was strongly considering it already.

As already mentioned, I have been at CODICO for more than four years. Time flies... Even if it feels like I joined yesterday; I cannot deny that many things happened in the meantime.

In four years, war happened... Covid happened.... We had to rethink our way of working, of interacting with colleagues, with customers, with suppliers. In addition, the electronic market – despite being a strong and robust market - has faced a component crisis. Markets like IoT and Electric Vehicles have been booming. Four years is indeed a long time. On my side, during these four years, I have met and married my wife, we started our own family and had a daughter together. I have also resumed practicing Basketball which I stopped playing for a while.

Talking about my hobbies, I love sports in general but especially Basketball which I am playing at a competitive level, I like playing Volleyball during summer and Padel with some friends. To introduce Padel briefly as not many people know this sport, it is a derivative from Tennis. Living in the south of France, and making sure the stereotypes apply in my case, I really enjoy playing »Pétanque« with friends and family. I also like hiking. My favorite destination for vacation is the mountains, I really enjoy spending time close to the mountains anytime of the year.

Some words about my personality, I consider myself as a social person, I really love interacting with people. Especially with people from different areas, with different habits. I am always looking forward to meeting new colleagues that embrace the CODICO values as much as I do.

Thank you for reading this introduction of myself, I am looking forward to our next interactions.

D05

▶ Denis Barranco, +43 1 86305 217
denis.barranco@codico.com

Barbara Monson-Henke



Dear Impulse Readers! I see a friendly »good day« and a warm »welcome« for our customers as my main task at the reception.

»Hospitality« has always been both my greatest strength and my passion. In earlier years, I lived this out in the context of looking after patients while working as a medical assistant. Finally, during the past eight years, I have worked as a receptionist in various companies.

At CODICO, I am the contact person for many different concerns of guests and colleagues and help with small and larger organisational matters and requests, in addition to the classic tasks of a receptionist.

Born and raised in Bern (Switzerland), I was drawn to the south of Switzerland at a young age. I worked for many years as a medical assistant in various medical practices and hospitals around Lugano and learned the Italian language in the process.

In 2000, I moved to Hong Kong with my husband, who has American roots, for professional reasons. We spent three exciting, wonderful and instructive years there. I used the time to further my education and attended the School of Holistic Aromatherapy in Sheung Wan.

Four years after our return to Switzerland, the next challenge was already waiting for me. Together with my husband, we left our families and our familiar home again, with the children still young at that time, to create a new home in Mödling.

After ten years, I found my professional home at CODICO. I will never forget the warm welcome and the valuable support of my new colleagues here. Despite many challenges, including the pandemic and the subsequent changes in my own job, I enjoy working for the company, which is an important pillar in my life. What I find particularly attractive at CODICO is the Academy Week, which allows me to get together with my colleagues from different countries several times a year. During this week, I can live out my passion and feel comfortable in the midst of this diversity of cultures and mentalities.

As I am always around a lot of people during work, I enjoy the peace and quiet and retreat in my free time. I like to hike through the vineyards at Eichkogel and the Vienna Woods or stroll through Mödling's pedestrian zone. In summer I like to swim my lengths in the Mödlinger swimming pool and plan smaller bike tours. Whenever possible, I of course also travel to my home country, with which I still have strong ties.

I look forward to welcoming you at the CODICO reception desk!

D06

▶ Barbara Monson-Henke, +43 1 86305 293
barbara.monson-henke@codico.com



CODICO GmbH | Zwingenstrasse 6-8 | 2380 Perchtoldsdorf | Austria

Phone: +43 1 86 305-0 | Fax: +43 1 86 305-5000

office@codico.com | www.codico.com