

ENGLISH

C O D I C O <sup>®</sup>

# impulse <sup>2/2022</sup>

 **electronica 2022**  
Messe München | November 15-18  
**VISIT CODICO @ BOOTH C3.141**



Female



Female  
Age 35%



## QUALCOMM's SoC Roadmap for the Edge IoT Market

Electronica-Highlight: RUBYCON's PMLCAP Bar for EVs

PIEZO MOTION: Top Precision Motors

# CONTENTS



## 04 | QUALCOMM'S BIG VISIONS

Edge Computing or Edge IoT is a recent development in the IoT market that is enjoying explosive growth in recent times. These terms refer to a recent development in distributed computing whereby computers, cameras and sensor processing systems are deployed in the same physical space where machines, robots and people connect and interact with the digital world. QUALCOMM's SoC Roadmap meets the needs of this market.

## ACTIVE COMPONENTS

- 04** | QUALCOMM's SoC Roadmap for the Edge IoT Market
- 07** | **Whitepaper Online:** Energy-Efficient Communication
- 08** | GateMate™ – Eval Kits and Design Flow for FPGAs from COLOGNE CHIP
- 10** | Displays for E-Charging Stations: Overview of Key Requirements
- 13** | The new »Golden Block« SMT-Terminals from SILVERTEL
- 14** | TOREX: XC9145 Ultra-Low Power Boost DC/DC
- 16** | New Wi-Fi6 PCIe Radio Module 8266P-PR from FN-Link
- 17** | SILVERTEL's Intelligent USB-C DC/DC POL for up to 10A
- 18** | MPS: Technological Leap in Powering Systems with Isolated Signal Transmissions

## CODICO IN-HOUSE

- 04** | When the World Starts Spinning Faster: ISO 9001
- 21** | **electronica 2022: Information and Staff Calendar**
- 58** | CODICO Team

## PASSIVE COMPONENTS

- 24** | Snap-In Type E-Caps from RUBYCON in Miniaturized Size
- 26** | TXC: Evolution of the TXC ThermoSym OXCO
- 28** | Electronica-Highlight: RUBYCON's PMLCAP Bar for EVs
- 30** | KDS: More Flexibility for Oscillators with Arkh.3G Technology
- 33** | EATON's Filter-Innovation for Intelligent & Autonomous Vehicles
- 34** | Applications of CELDUC's Solid State Relays in Industry 4.0
- 37** | AISHI: THB Film Capacitors for High Performance Applications
- 38** | PANASONIC's Polymer Capacitors for Harsh Environments
- 40** | Absorbing Voltage Peaks with ISABELLENHÜTTE
- 42** | ISABELLENHÜTTE: Current measurement for a 230VAC/32A charger
- 43** | High Performance PCB Power Relay from SONG CHUAN



## CONNECTORS

- 44** | AMPHENOL: Automotive Interconnect Solutions for EV Charging
- 46** | PwrBlade® MiniMezz Connector Series from AMPHENOL
- 46** | AMPHENOL's FPC-to-Board Connector FlexLock®
- 47** | CVILUX: CP35 Connector System According to IEC 60335-1
- 48** | DINKLE: From Pioneering Terminal Blocks to Tool-Free Solutions
- 50** | Good Vibrations: Floating Board-to-Board Connector from HIROSE
- 51** | HIROSE: Robust Wire-to-Board Connector for 125°C Temperature
- 52** | HIROSE's Wire-to-Board Connector for Electric Shock Prevention
- 53** | M8: Hybrid Single Pair Ethernet Cable Assemblies from SINBON
- 54** | PIEZO MOTION: Precision Motors Without Premium Price Tag
- 56** | ECO-TRONIC PL: The Safely Latching Connector from STOCKO
- 57** | YAMACHI: New RJ45 Metal Cover with IP69K Protection

# When the World Starts Spinning Faster

## CODICO gets extra time!

It currently seems like the world is turning faster than ever before. Just when we thought we had overcome one crisis, the next one is already heading our way. Both external and internal changes are having an impact on our daily work. Technological progress, digitalisation, and automation come with a lot of benefits. And yet it's not always easy to keep up with the incredible pace.

What prevents us from spiralling off course at such speeds is our Quality Management System (QMS). Our ISO 9001-certified QMS has been the backbone of the company for more than 25 years. It provides us with orientation and acts as a framework, ensuring the best possible workflows. Knowledge is documented and available at all times, competencies and responsibilities are clearly defined, so everything goes hand in hand. This year, we get extra time. Following an intensive review of our processes by our certification body Quality Austria, our ISO certification has been extended for another 3 years. We're very pleased!

Do you wish to receive a copy of our certificate, or want to find out more about our QSM system? Please contact

**D01**

▶ Petra Landschau, +43 1 863 05 169  
petra.landschau@codico.com

## Awarded – Excellent Supplier!

LOGICDATA Electronic & Software Entwicklungs GmbH has named CODICO »Best supplier« in the category electronics for its performance in 2021.

Mrs. Malli/Global Category Manager and Mr. Rämbitsch/Head of Purchasing personally presented the award to us during their visit to our headquarter in Perchtoldsdorf.

Thank you – very much appreciated!



Sven Krumpel  
CEO CODICO



## See you!

Dear readers, the world's leading trade fair for electronics is just coming up and CODICO cordially invites you to join us! The CODICO team will be welcoming you in Hall C3, Stand 141, and is looking forward to informing you about the latest trends, technologies and products. In addition to technical highlights and the presentation of current applications, you can expect Austrian hospitality, a warm get-together and fun at our exhibition game. Starting on page 21, you'll find an overview of our CODICO team on site! Take the opportunity to meet us in person.

A trade fair like electronica is always an opportunity to look into the future! Suppliers bring their latest developments to the market, companies present the latest trends. This time, CODICO is focusing on exhibiting customer applications. We'll show you how our technical know-how can help you to achieve your final solutions. You'll also find the right technologies and products from CODICO for the individual application areas. This allows you to quickly and easily see the solution for your application, and our experts will be on your side on site with our design-in support. Our highlights on the stand will be in the areas of EV charging, audio, robotics, motion control, home automation, photovoltaics and new energy! Take a look at our EVSE simulator to get an idea of our expertise in this area. We are driving the growth of EV charging infrastructure and will show you a selection of products that you can use in DC and AC charging stations.

And don't just get in touch with us about our highlights! We are also here for you in the area of recruiting! If you are interested in CODICO, you can always find our current open positions at [www.codico.com/en/career](http://www.codico.com/en/career). We are a little different from other companies! We take values like family, responsibility and dynamism seriously. Every single person here contributes to our joint success! Perhaps you will too in the future! With this in mind: See you at electronica!

▶ Sven Krumpel







# BIG VISIONS

## QUALCOMM's SoC Roadmap Meets the Diverse Needs of the Edge IoT Market



Edge Computing or Edge IoT is the latest development in the IoT market that is enjoying explosive growth in recent times. These terms refer to a recent development in distributed computing whereby computers, cameras and sensor processing systems are deployed in the same physical space where machines, robots and people connect and interact with the digital world.

Edge IoT is deployed when machine decision making needs to take place in real time and where there is a very high volume of on-site sensor data generated that is difficult to send to an off-site network (privacy regulation or connectivity issues for example). Some good examples

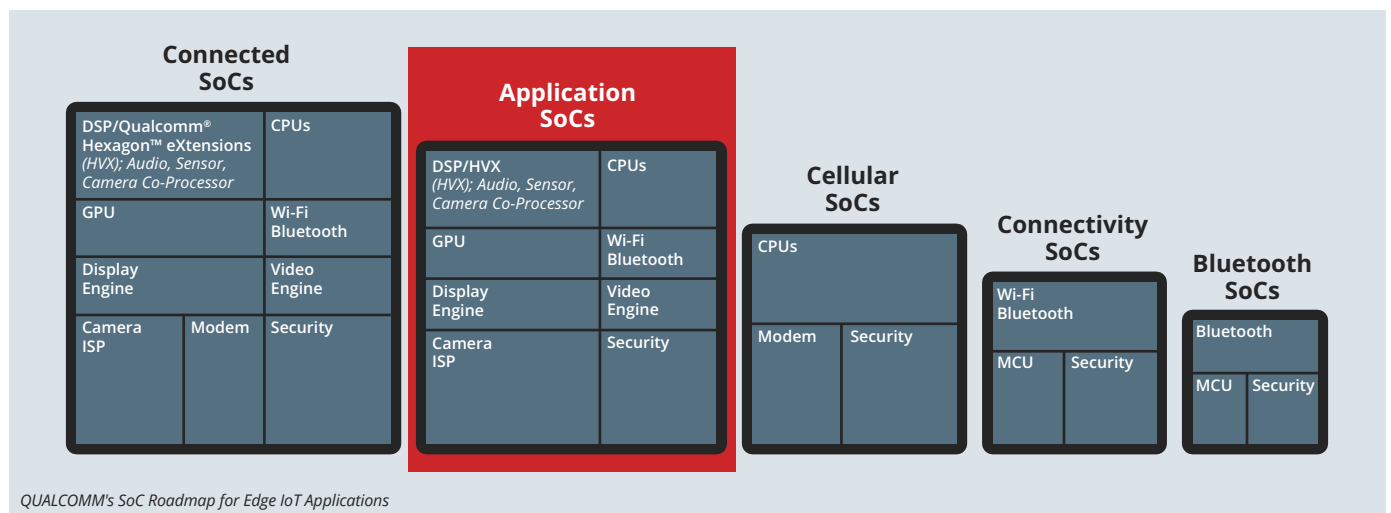

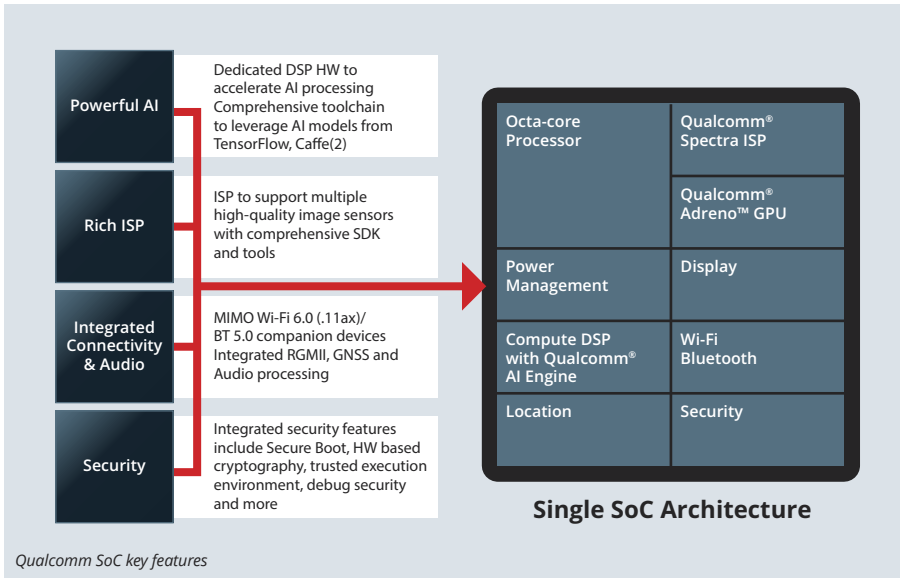

of Edge IoT applications include warehouse order fulfilment, factory robotic systems, on-site retail, self-checkout and personal safety monitoring systems, train and airplane entertainment. Analysts predict the Edge IoT market to be worth up to 155 billion USD by 2030 with Gartner forecasting up to 18 billion devices will deliver Edge IoT services by 2030. To meet the needs of such a diverse set of use cases presents a challenge for the semiconductor industry.

CODICO's long-time partner QUALCOMM has been busy in recent years developing SoC solutions that combine their technology strengths in computing and AI, camera, wireless connectivity and audio to develop one of the most comprehensive roadmaps of SoC devices to support the many Edge IoT applications (see diagram on the left). QUALCOMM SoCs for IoT are capable of

powering all manner of devices, from low power IoT sensors to Voice UI capable headsets, hand-held scanners, control panels, multi-camera and display automation, digital signage systems to robots, AGV's and drones. For each of these applications a highly integrated SoC solution is available to meet the power consumption, price and performance requirements. In this article we will take a closer look at the Application SoC roadmap for Edge IoT applications.

QUALCOMM's range of Connected and Application SoCs offer a common architecture, the devices combine powerful compute and AI processing along with dedicated hardware blocks for camera, display, security and sensor processing. The highly integrated devices simplify hardware design complexity and provide for an optimised form factor. The current state of semiconductor supply presents designers and engineers with an unprecedented challenge as they try to identify semiconductor devices for their new products. QUALCOMM's IoT roadmaps offer another advantage in this regard. The SoC devices are not provided as standalone devices, a portfolio of companion power management (diagram below),

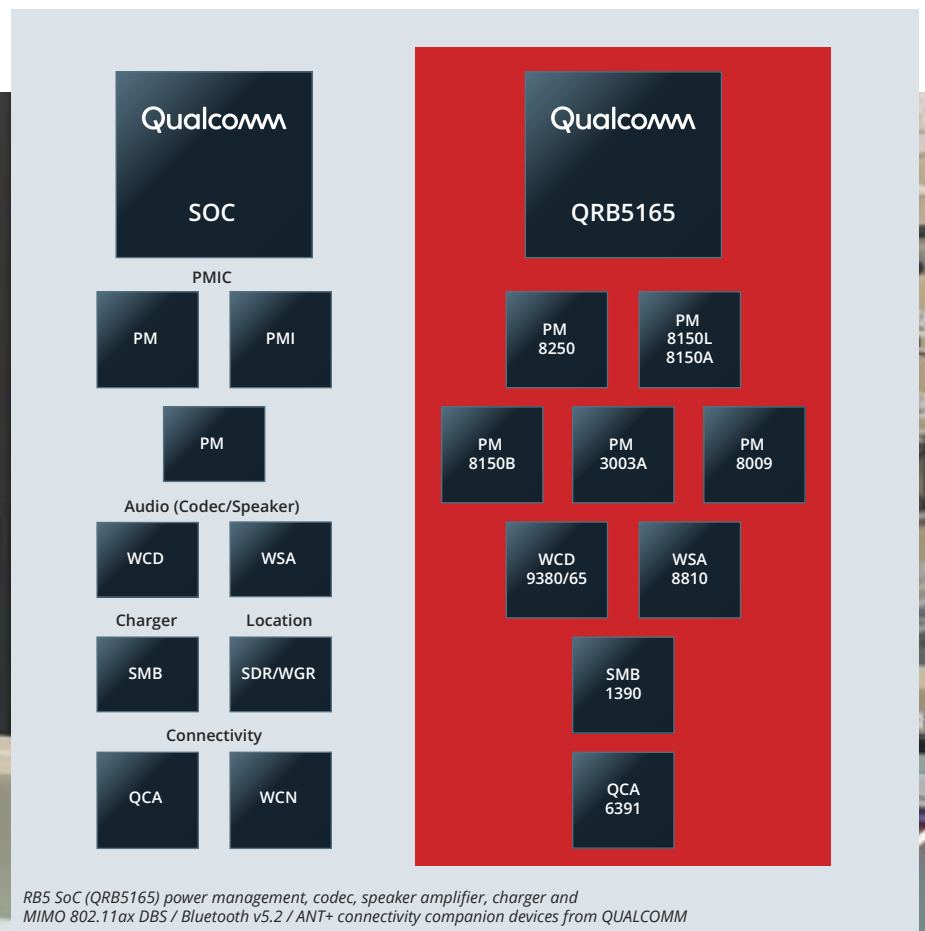

audio CODECS, power amplifiers, charging, location and wireless connectivity solutions are available from QUALCOMM to accompany each of these SoC devices.

QUALCOMM's Application SoC processors are tiered according to SoC performance, capabilities and pricing. The matrix below captures a high-level overview of the key capabilities of each SoC available from QUALCOMM today. Entry level devices are optimised to meet a specific application for example the QCS405 for wireless audio or the QCS2290 for retail and industrial handheld devices. While SoCs in the higher tiers such as the QCS610 offer more capabilities and perfor-

mance to allow designers to adopt the SoC for several use case such as Retail and Security cameras, Industrial Control Panels and Robotics.

QUALCOMM's SoC devices share a common architecture which enables designers to build a family of Edge IoT products using these devices while reusing software across the device family. In some cases, pin for pin compatible devices such as the QCS2290/QCS4290 and QCS410/QCS610 are offered to meet the unique requirements of Smart Connected Camera and POS/handheld market segments. Extended product lifetimes and extended temperature ranges are yet another requirement in the Edge IoT market which

the QUALCOMM roadmap offers. As we covered in our last issue of Impulse a range of system on module SOM solutions from QUALCOMM's joint venture partner THUNDERCOMM and others are also available for those customers wishing to reduce design effort, risk and time to market.

We expect the Edge IoT market to be a significant opportunity for our customers in the coming years. Please come and see us at electronica to discuss if one of the QUALCOMM SoC or THUNDERCOMM SOM can meet your requirements.

A01

▶ Thomas Carmody, +43186305362  
thomas.carmody@codico.com

### QUALCOMM's SoC Selector Guide

	PROCESSOR	CPU CLOCK SPEED	CPU CORES	CPU ARCHITECTURE	DSP TECHNOLOGY	WI-FI STANDARDS	BLUETOOTH VERSION	GPU	CAMERA	VIDEO	OS	SIZE	EXTENDED LIFE
Premium Tier	Qualcomm® QCS8250	Up to 2.84GHz	8x Kryo 585 CPU	64-bit	Hexagon™ 683 DSP	2x2 802.11ax MIMO	5.1	Adreno™ 650 GPU	64MP	4K120	Android	1099 MPSP (LPDDR5) 14.0 x 12.4 x 0.56 mm 0.35mm pitch	•
	Qualcomm® QRB5165	Up to 2.84GHz	8x Kryo 585 CPU	64-bit	Hexagon™ 698 DSP	2x2 802.11ax MIMO	5.1	Adreno™ 650 GPU	64MP	4K120	Linux Ubuntu	1099 MPSP (LPDDR5) 14.0 x 12.4 x 0.56mm 0.35mm pitch	•
	Qualcomm® SDA845	Up to 2.8GHz	8x Kryo 385 CPU	64-bit	Hexagon™ 685 DSP	2x2 802.11ax MU-MIMO	5.0	Adreno™ 630 GPU up to 653MHz	28MP	4K60	Linux	914B MPSP 12.4 x 12.4 x 0.58mm 0.35 mm pitch	•
	Qualcomm® QCS605	Up to 2.5GHz	8x Kryo 300 CPU	64-bit	Hexagon™ 685 DSP	2x2 802.11ax MU-MIMO	5.1	Adreno™ 615 GPU up to 780MHz	32MP	4K60	Linux Android	771 PSP 11.1 x 10.5 x 0.99mm 0.35mm pitch	•
High Tier	Qualcomm® SDA660	Up to 2.2GHz	8x Kryo 260 CPU	64-bit	Hexagon™ 680 DSP	2x2 802.11ac MU-MIMO	5.0	Adreno™ 630 GPU up to 653MHz	25MP	4K30	Android	692 NSP 12 x 12 x 0.90mm	•
	Qualcomm® QCS610	Up to 2.2GHz	8x Kryo 360 CPU	64-bit	Hexagon™ 685 DSP	1x1 802.11ac	5.0	Adreno™ 612 GPU up to 845MHz	24MP	4K30	Linux	806 PSP 11.1 x 12 x 0.92mm 0.35mm pitch	•
	Qualcomm® APQ8053Pro	Up to 2.2GHz	8x Arm Cortex A53 CPU	64-bit	Hexagon™ 546 DSP	1x1 802.11ac	4.1	Adreno™ 506 GPU up to 650MHz	21MP	1080p60	Linux Android	857 NSP 14 x 12 x 0.84mm 0.4mm pitch	•
	Qualcomm® APQ8053Lite	Up to 2.2GHz	8x Arm Cortex A53 CPU	64-bit	Hexagon™ 546 DSP	1x1 802.11ac	4.1	Adreno™ 506 GPU up to 650MHz	24MP	4K30	Linux Android	857 NSP 11.1 x 12 x 0.92mm 0.35mm pitch	•
Mid Tier	Qualcomm® QCS410	Up to 2.2GHz	4x Kryo 360 CPU	64-bit	Hexagon™ 685 DSP	1x1 802.11ac	5.0	Adreno™ 612 GPU up to 845MHz	21MP	1080p30	Linux	806 PSP 11.1 x 12 x 0.92mm 0.35mm pitch	•
Entry Level	Qualcomm® APQ8009	Up to 1.3GHz	4x Arm Cortex A7 CPU	32-bit	Hexagon™ 536 DSP	2x2 802.11n MU-MIMO	4.1	Adreno™ 304 GPU up to 456MHz	16MP	1080p30	Linux Android	504 NSP 11.1 x 12.0 x 0.96mm 0.4mm pitch	•
	Qualcomm® QCS405	Up to 1.4GHz	4x Arm Cortex A53 CPU	64-bit	Hexagon™ QDSP v66 DSP	2x2 802.11ac	5.1	Adreno™ 306 GPU up to 600MHz	N/A	N/A	Linux	722 NSP 14 x 14 x 0.91mm 0.4/0.5mm mix pitch	
	Qualcomm® QCS404	Up to 1.4GHz	4x Arm Cortex A53 CPU	64-bit	Hexagon™ QDSP v66 DSP	2x2 802.11ac	5.1	N/A	N/A	N/A	Linux	722 NSP 14 x 14 x 0.91mm 0.4/0.5mm mix pitch	

# WHITEPAPER ONLINE!



## Energy-Efficient Communication for Battery-Powered Devices

### How can the life of batteries in mobile networks be improved?

The challenge for battery-powered sensors in the Internet of Things is to get by with the available energy for as long as possible. This can be achieved in many ways. The simplest is to leave a device switched on only intermittently, spending the rest of the time in sleep mode. Since it is not accessible in sleep mode, developers have to find a good compromise between data actuality and idle time.

CODICO has released a whitepaper series, where we highlight some aspects around the topic of energy saving. We explain how to achieve the maximum runtime for a devices and where obstacles can be expected. An important factor for the energy consumption of an IoT device is the amount of data that is transmitted with each communication. The more data, the longer the device must remain active and the greater the power consumption become. In the whitepaper series we discuss different ways to save power such as

the choice of the appropriate communication protocol, which can make a significant contribution to extending the life of battery-powered sensors.

#### Part 1: Save energy with the right hardware-setup

In the first part of the whitepaper series, we look at the process of network search and registration. Where are the opportunities to save power and how can the IRAT timer provide support? Furthermore, we explain two functions for saving power – »Power Saving Mode« (PSM) and »Extended Discontinuous Reception« (eDRX) – and show their possibilities and limitations.

#### Part 2: MQTT, CoAP & LwM2M – the lean protocols for the IoT

Part 2 covers the three »lean« protocols mentioned above whose functions, unlike PSM and eDRX, do not depend on individual network operators. We explain MQTT, which is aimed at em-

bedded devices in non-TCP/IP networks, CoAP, a connectionless, packet-oriented protocol that can connect to multiple servers, and LwM2M, which is based on CoAP and includes elements of device management.

#### Part 3: 1NCE Data Broker: more battery life under NB-IoT & LTE-M

Choosing a suitable communication protocol with NB-IoT and LTE-M (Cat M1) mobile radio can significantly contribute in increasing the lifetime of battery-powered sensors. Optimally configured, these measures can achieve additional energy savings – more than if only network-based activity intervals are used via PSM or eDRX alone. We review this with a test setup in Part 3.

You want to learn more? Access the whitepaper series here: [www.codico.com/en/low-power-connectivity](http://www.codico.com/en/low-power-connectivity)

A02

▶ Joachim Strohschenk, +49 89 130143817  
joachim.strohschenk@codico.com





# GateMate™

## Eval Kits and Design Flow for the FPGAs from Germany



FPGAs are suitable for a wide range of applications. In order to quickly test an idea or to evaluate the new GateMate™ FPGA family from COLOGNE CHIP, the manufacturer offers an evaluation kit with a variety of interfaces.

### Interfaces and functions on the Evaluation Board

- USB host interface
- JTAG interface
- SPI interface
- On-Board Flash Memory
- Serializer/Deserializer (SerDes) interface
- Pmod-compatible interface
- On-Board HyperRAM Module
- 108 general purpose Inputs and Outputs (GPIOs)
- VCore (0,9 to 1,1V) and Vio (1,2 to 2,5V)
- 7 Status LEDs

The GateMate™ Evaluation Board is equipped with the new GateMate™ A1 FPGA. To provide the

widest possible range of applications for your evaluation, the evaluation board provides all the minimum required peripheral components such as memory, clocks and access to a large number of interfaces and allows control over the core and IO voltages. This configuration can be used to control the speed and power consumption of the system.

The GateMate™ family ranges from 40k to 1 million lookup tables. These address all application requirements of small to medium sized FPGAs. The GateMate™ device A1 is now available in production quantities. The GateMate™ development system can be downloaded free of charge from Github, it includes a Verilog or VHDL synthesis

tool, a Place&Route tool, develops output files for simulators and generates the bitstream file for programming the FPGA. An exemplary development flow from the design input to the configuration file can be seen in picture 2.

RTL synthesis from VHDL or Verilog is performed using the open source Yosys synthesis software suite. Yosys includes extensive Verilog support. For developments in VHDL abstraction language





### Feature overview of the GateMate™ FPGA evaluation board version 3.1

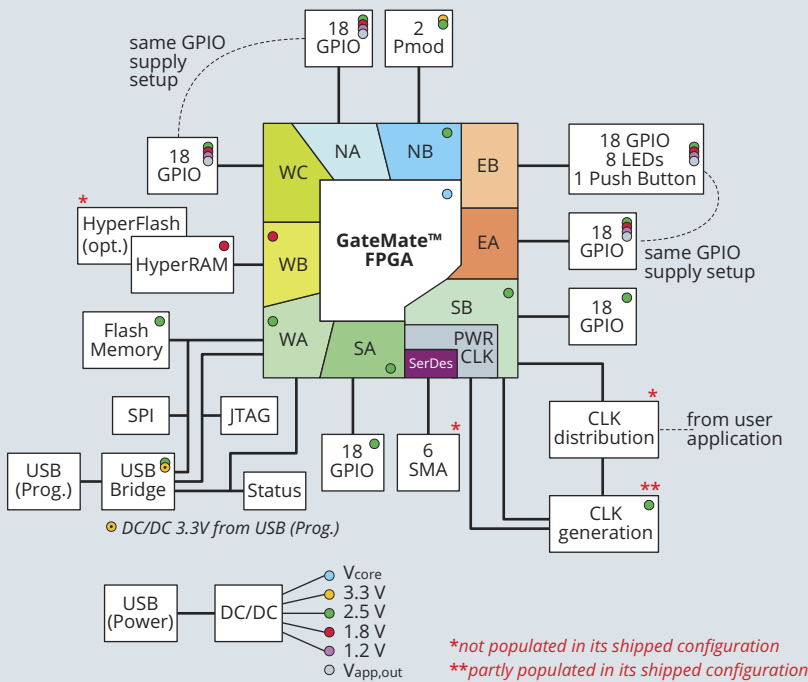

Picture 1

Production takes place in GF Factory 1 in Dresden on the basis of the power-saving 28SLP technology. This minimises the risk of trade restrictions or high customs duties with GateMate™ FPGA. The A1 is the first member of the family which is available in production quantities and the A2 is planned to be delivered to customers as samples in Q2-2023.

### GateMate™ FPGA features

- Logic capacity: 20,000 up to 500k logic cells
- Dual port SRAM 1280kBit
- Three operating modes: Low Power, Economy, Speed
- FPGA in ball grid package for small size and high pin count
- Only two signal layers required on the PCB
- General Purpose IOs (GPIOs) configurable as single-ended or LVDS
- Low number of configuration bits
- Configuration with 4Bit SPI interface up to 100MHz
- No excessive start-up currents
- Multiple clocking schemes
- Dual-port block RAMs with 1 to 80Bit data width, also configurable as FIFO
- Multipliers with any bit width of the factors can be implemented
- SERDES 2.5Gbit/s
- Pull-up/pull-down resistors configurable
- Support for ADC & DAC with additional IP cores
- Three operating modes: Low Power, Economy, Speed by varying the core voltage to depending on the application mode: 0.9V, 1.0V, 1.1V
- GateMate™ Place & Route with automatic clock skew optimisation
- Static timing analysis for performance evaluation

The configuration file is loaded into the FPGA or an external flash with the OpenFPGAloader.

### FPGA hardware overview

The focus of the development was the use of a manufacturing process that allows both high densities and low power consumption, normally a major problem with SRAM-based FPGAs. COLOGNE CHIP was thus able to combine logic density, power consumption and package size with the lowest specific cost on the market for its GateMate™ family, making the devices suitable for small quantities in research but also for high-volume applications. The chips were not only designed, but are also manufactured in Germany. The successful product development was carried out in cooperation with Globalfoundries.

a GHDL to Yosys plug in is available, also other HDL description languages or tools with Verilog backend can be used. The synthesis generates a gate level representation of the design in the form of a Verilog netlist with architecture-specific primitives. This allows functional simulation or the netlist is passed to the COLOGNE CHIP placement tool. There, a bitstream is created for programming and if desired, a netlist with timing information. The timing simulation can be done for example with the 3rd party Icarus Verilog Simulator and the GTKWave Waveform Viewer.

For further questions please contact:

A03

➤ Achim Stahl, +49 89 130143814  
achim.stahl@codico.com

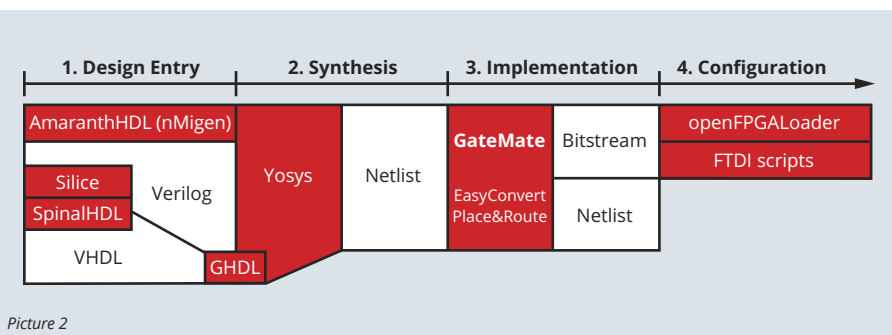

Picture 2

GateMate™ FPGA Sizes FBGA 320ball 15x15mm		
	CCGM1A1	20,480 CPEs
	CCGM1A2	40,960 CPEs
	CCGM1A3	81,920 CPEs

# DISPLAYS FOR E-CHARGING STATIONS



## An Overview of the Key Requirements

Voluntarily imposed or forced due to external circumstances the number of electrically operated vehicles is increasing rapidly. The corresponding charging infrastructure has to keep pace with this development, ideally it should be available at an early date. The projected compound annual growth rate (CAGR) for the period from 2022 until 2030 lies at 28%. Alone in Europe in the year of 2030 there is a predicted demand of 3,6 Million public charging stations.

CODICO has already been dealing with this topic for quite some time and has developed among other things PLC modules for communication between charging station and vehicle. Therefore, it should be obvious to dedicate yourself to the topic display as well. This is a detail that should not be neglected, since it is all about user-friendliness. A charging station can be designed simply and inexpensively. LED lighting modules and an app on your smartpho-

ne should be enough. Nevertheless, only a display increases the operating comfort.

Displays are primarily found at DC charging stations. These are larger and charge faster because the accumulator is charged directly in the vehicle. The display is a must-have and is used to show the charging status, charging time or remaining time and battery status. However, there is also an increased demand for displays for AC char-

gers. These charging stations are smaller (usually in the form of a wallbox) and charge more slowly because they use the on-board charger in the vehicles to convert from AC to DC. In accordance with EU Regulation 2014/94/EU, all publicly accessible charging stations must have a display, as is the case analogously for the traditional gas pump.

### Criteria for displays in charging stations

The many possibilities and options offered by the display market sometimes make it difficult to decide on the right display, or perhaps better a display that meets the requirements. Below we try to give some food for thought to help with a decision-making process. Let's go through the points in detail.

## 1. The size

The size essentially depends on what purpose must be fulfilled. Let's stick with DC chargers. The charging posts are larger; thus, it also makes sense to use displays in a suitable format. The most common sizes are 7 inches and 10.1 inches, although in some applications other diagonals can also be found. If you want to focus more on advertising – after all, a charging process takes a bit longer – then you'll go in the direction of 15 or 15.6 inches, perhaps even 21.5 inches. Larger displays can show more information and give the charging station an appealing look.

For AC chargers, displays are now also becoming standard. On the one hand, the stations must comply with calibration regulations, i.e., they must display the amount of energy delivered (see above); on the other hand, a display can have a positive influence on the appearance. The displays are naturally smaller in wallboxes. OLED displays or small TFTs are mostly used.

## 2. The optical characteristics

Large charging stations are often located outdoors. Good readability, even in sunlight, is therefore essential. This is achieved by very bright displays, typical values are 1000cd/m<sup>2</sup>, but up to 2000cd/m<sup>2</sup> are also quite recommendable. The

installation position can also contribute to this. If the display is mounted at an angle in the charging pole, it is shaded similar to the displays in a dashboard and therefore more visible.

Additionally, using optical bonding also pays off. Unwanted reflections that occur due to the air gap with air bonding are prevented. The image is significantly better in bright ambient conditions. A surface coating on a front glass can also help improve readability. An anti-glare (AG) coating scatters the incident light and ensures that the image content remains legible, although the contrast decreases a little. With an anti-reflective (AR) coating the incident light is reflected only at one angle, creating a bright spot, while the rest remains clear and visible. It is up to the designer's discretion which technique is used.

Small charging stations which are found in rows in parking lots are, by location alone, less endangered. It is therefore sufficient to use a brightness of approximately 500cd/m<sup>2</sup>, and it may also be possible to dispense with other readability-enhancing measures.

Finally, the display technology used also plays a not insignificant role. The best result can be achieved with IPS (In-Plane Switching) displays.

Excellent viewing angles horizontally as well as vertically, high contrast and fast response times are the main features. The MVA (Multi-Vertical Alignment) displays have similarly good properties.

The most cost-effective variant, however, is TN (twisted nematic) technology. The viewing angles are not as wide as with the two aforementioned technologies, but can be improved with the help of a special polariser (O-film). Unfortunately, this is at the expense of the brightness. If you do not want to accept this, you need to use a brighter display. In addition one should consider the viewing angle (6 o'clock vs. 12 o'clock).

## 3. The temperature behaviour

Another essential point is the operating temperature range. Is the charging station located outdoors the display can quickly get hot in summer and correspondingly cold in winter. Temperatures from +80°C or -30°C, in some regions -40°C, can certainly be achieved.

For that reason it is necessary to choose displays that withstand these temperatures. Heat input from outside can be reduced by an IR blocking filter (heat absorption filter) so that the display is not subjected to additional stress. Of course,





attention must also be paid to the thermal management of the charging station itself so that the display does not additionally heat up due to internal waste heat.

OLED displays have a clear advantage here, because their operating temperature range extends from  $-40^{\circ}\text{C}$  to  $+70^{\circ}\text{C}$ ,  $80^{\circ}\text{C}$  and in some cases even up to  $105^{\circ}\text{C}$ . The majority of LCDs operate at  $-20^{\circ}\text{C}$  to  $+70^{\circ}\text{C}$ , with a smaller number of models also reaching  $-30^{\circ}\text{C}$  to  $+80^{\circ}\text{C}$ .

In this context, exposure to UV radiation should not go unmentioned. If prolonged exposure to UV light is expected, countermeasures, for example UV filters, must be taken. A possible printing on a front glass should then also be made with ceramic inks, as organic inks can peel off.

#### 4. The operation

Of course, a charging station can be operated via buttons and keys, but nowadays a touch screen is state-of-the-art. However, resistive touches are not recommended for such an application. They are inexpensive, but can easily be damaged. That leaves the projected capacitive touch. The handling is intuitive, whether as single or multi-touch. It is important that the touch can be adapted to certain circumstances or adjusts to them automatically. For outdoor charging stations, water (think of rain) must not trigger any function. A function in contact with gloves (at least with thin ones) should be ensured if possible. Both together is not easy to realise. It depends on the choice of the right touch controller.

#### 5. The mechanics

Equipment in public places must also survive damage and vandalism. In terms of the display, this means that safety precautions have to be taken to prevent them. A thick front glass behind which the touch and display are then located is the most common method. Depending on the specific requirement, the thickness can range from 3 to 10mm. In addition, optical bonding helps to make the entire display unit more robust. The glass can therefore be chosen a bit thinner without sacrificing resilience. Chemically or thermally tempered glass is an additional safety factor.

PMMA, commonly known as Plexiglas, as a front protector is flexible and breaks heavily, but it has the disadvantage of being easily scratched. Who



wants to charge their vehicle at a charging station with an unsightly display? Glass is much more robust.

The installation in a housing also needs to be considered. The unit can be mounted from the front or the back. It is essential to ensure that this is waterproof and the electronics in the charging pole are protected. IP65 is usually specified for this. The use of industrial adhesive tapes or special industrial adhesives is mandatory. For wallboxes and smaller AC chargers, the focus is primarily on the design. Due to the special shape, it can happen that a completely customized display including touch and front glass is developed.

#### 6. The electrical connection

If we consider the display as such, the communication for the mainly used sizes (7" to 21.5") is done via LVDS interface. The advantages are obvious: differential signals - therefore less susceptible to interference; long lines, several meters

are possible - display and computer can therefore be distant from each other; low power consumption; low number of lines. Naturally, other interfaces, such as RGB or MIPI are also used, but are not as common at the moment.

HDMI represents its own variant, so to speak. The interface is standardised and offers a direct connection possibility, for example to a BOX PC, which fulfills control tasks. On the display side, a corresponding adapter board is required to convert HDMI to the respective display interface.

If additional electronics are already available on the display side, the way to higher integration is not far. Available are displays that allow a direct connection of a Raspberry module. The display gets additional intelligence, e.g. the GUI (Graphical User Interface) can be stored there and does not burden the computer responsible for the charging electronics. This can therefore be realised more cost-effectively.



## New »Golden Block« SMT-Terminals



SILVERTEL has launched a new format of their exceptionally popular Ag99XX product range. The entire series will now be available with block terminals instead of the traditional pin headers (whether DIL or SMT format).

Suffixed with Ag99XX-MTB or Ag99XX-LPB, these new variants are designed to be functionally compatible with their predecessors, the »MTB« and »LPB« versions will become the preferred option for supply available in the smallest package on the market, measuring an astonishing 22x14mm only.

The previous variants »M« and »MT« (SMT pin header) are replaced by the MTB variant, which will include thermal protection on-board and comprise of 3.3, 5, 12 and 24V versions. The LPB variant, the smallest PoE PD Module on the planet, will supersede the previous -LP variant (DIL pin header with lowest profile of less than 9mm) and will be available in 3.3, 5 and 12V versions, again having on-board, thermal protection.

The -M/MT and -LP variants will become »Not Recommended for New Designs« (NRND) and despite continuing to be supported in production, customers will be encouraged to switch to the new variants over time.

Additionally, the new »MTB« and »LPB« variants will be available in trays or tape & reel (subject to MOQ), thereby lending themselves more readily to auto-placement assembly.

Samples are available via the CODICO Sample Shop.

### CONCLUSION

There are many points to deal with when selecting a display for charging stations. With the above overview, we would like to point out what we consider to be the important points.

If you go into detail, there are other aspects that are worth examining. In general, the points apply not only to charging stations, but actually to many similar applications, such as info terminals, vending machines etc. Take advantage of our expertise! Discuss your project with us!

If you go further in this direction, you'll end up with the smart display. Intelligence is shifted to the display, and the computing power required for the entire system is distributed. This allows the modular design of a charging system. The connection to other modules is made via CAN-bus or RS485.

Whether it is the choice of a suitable display or a desired customisation, we are at your disposal.

A04

▼ Christian Forthuber, +43 1 86305 158  
christian.forthuber@codico.com

A05

▼ Andreas Hanausek, +43 1 86305 131  
andreas.hanausek@codico.com

# ECONOMICAL

## XC9145: Ultra-Low Power Boost DC/DC from TOREX



©AdibSaeed/Southworks

Ultra-low quiescent current is important in most of today's IoT, wearable & hearable devices and as the supply current of the Power Management IC itself accounts for a major share of the total power consumption, this has a big impact on battery life. In addition, consumers expect their devices to have a longer operating time with less frequent charging. The new XC9145 from TOREX helps to solve both issues with a quiescent current of only 400nA.

The XC9145 also features an enable pin to turn the IC on and off (during stand-by, all circuits are shutdown to reduce consumption to 0.1µA max.)

### High Efficiency at Light Loads

The 400nA quiescent current also contributes to high efficiency at light load currents, making the

The XC9145 series is an ultra-low power PFM/PWM step-up synchronous DC/DC converter. Input voltage range is from 0.65V~5.5V (operation start voltage is 1.6V but the XC9145 can then operate down as low as 0.65V in operation) and output voltage is selectable in 0.1V increments between 3.0V~5.5V.

Output current of 300mA is possible when stepping up from 1.8V to 3.3V and 430mA when stepping up from 3.3V to 5.0V. An efficient step-up circuit can be configured using only 3 external caps and a small inductor as shown in Figure 1.

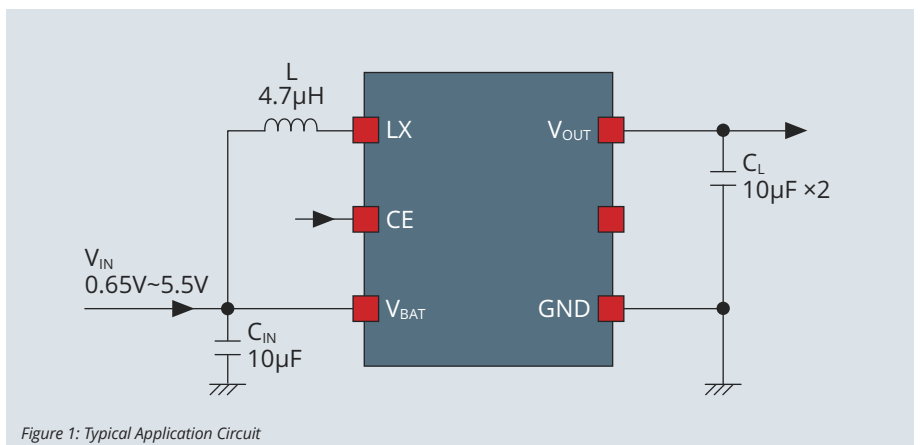

Figure 1: Typical Application Circuit



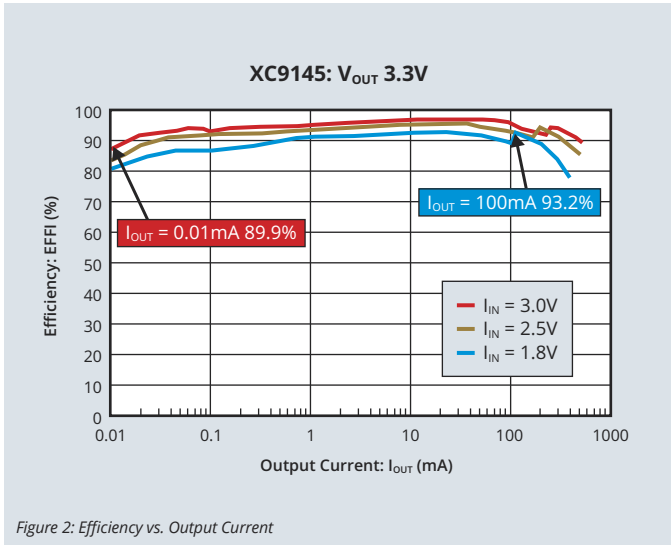

Figure 2: Efficiency vs. Output Current

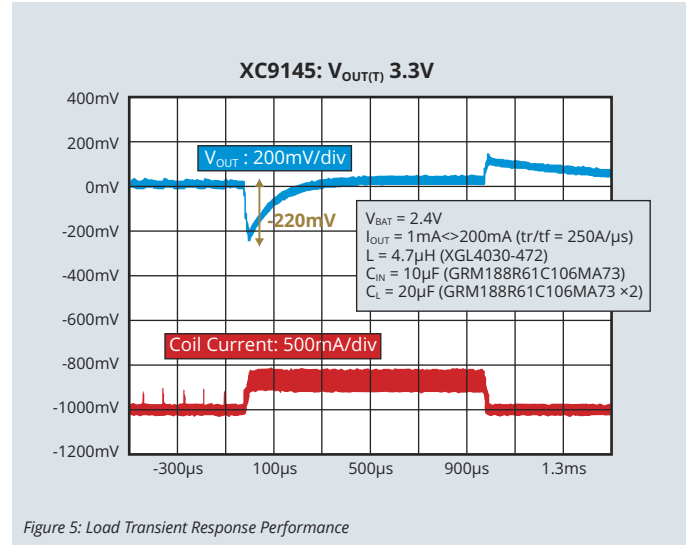

Figure 5: Load Transient Response Performance

XC9145 a solution that truly helps to extend battery life in battery powered applications.

Figure 2 shows the efficiency of the XC9145 at light load currents (within the range of 0.01mA to 0.1mA), is much improved when compared to a conventional low power PWM/PFM auto switching boost DC/DC. At 0.01mA, the efficiency of the XC9145 is still almost 90%.

### Maximising Battery Life

Through use of the Load Disconnect Mode, the XC9145 delivers a dramatic improvement to the power loss under sleep mode compared to previous products, decreasing power consumption by 74% compared to the conventional PWM/PFM XC9142 and 53% compared to the Low Power XC9140. Figure 3 and 4 shows the loss comparison with other TOREX boost DC/DC products, under the following conditions:

$V_{IN} = 1,8V \rightarrow V_{OUT} = 3,3V$   
 Activ:  $I_{OUT} = 10mA@10ms \leftrightarrow$   
 Sleep:  $I_{OUT} = 5\mu A@10s$

The energy saving in sleep mode is so great that the battery life is doubled compared to the XC9142. This gives design engineers the opportunity to opt for smaller batteries in the design where space is at a premium.

### Fast Transient Response

The XC9145 is ideal for applications that require repeated on/off switching, such as smart meters. As shown in figure 5 the voltage recovers quickly with minimum ripple (noise) maintaining a stable  $V_{OUT}$ .

### Space Saving Packages

The XC9145 series is available in two PCB space saving packages – the USP-6C and the WLP-6-05.

At  $1.8 \times 2.0 \times 0.6mm$  the USP-6C is very small and suitable for many applications but if further space saving is needed, the WLP-6-05 is the better choice. This is almost half the size of the USP-6C and measures only  $1.08 \times 1.28 \times 0.4mm$ .



You can get more information from CODICO as usual.

A06

➤ Johannes Kornfehl, +43 1 86305 149  
 johannes.kornfehl@codico.com

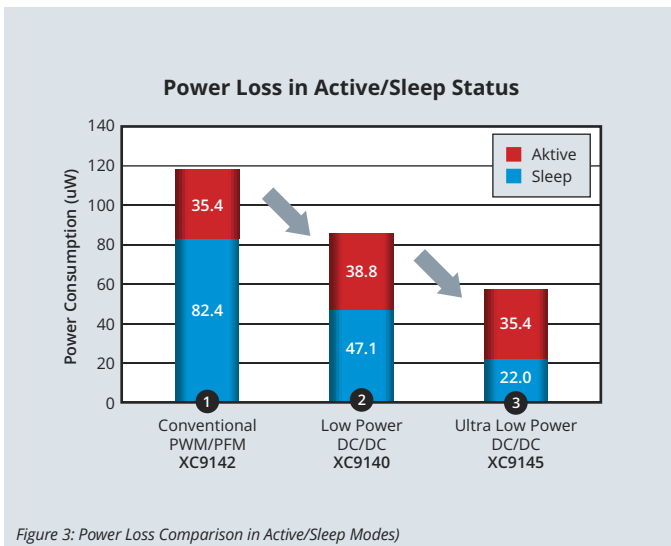

Figure 3: Power Loss Comparison in Active/Sleep Modes

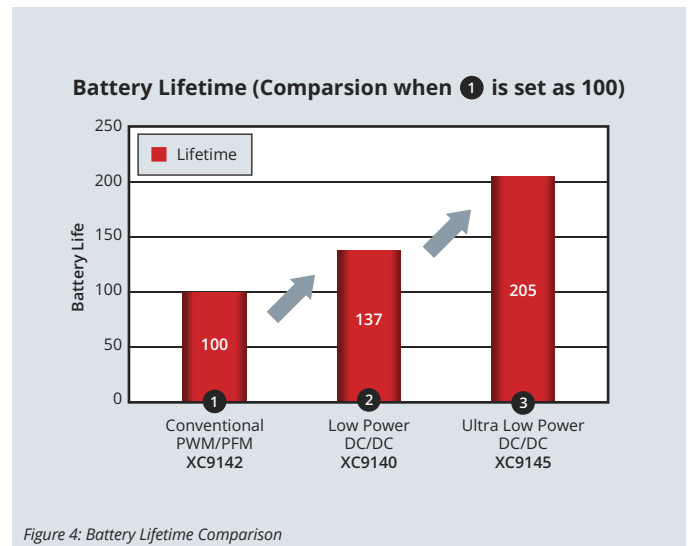

Figure 4: Battery Lifetime Comparison



# WI-FI6

## New PCIe Radio Module 8266P-PR from FN-Link

FN-Link is expanding its product portfolio of PCIe radio modules for Wi-Fi6 applications. The new module, designated 8266P-PR, is based on QUALCOMM's brand new QCA-2066 chip, which is capable of Wi-Fi6 DBS (Dual Band Simultaneous) for the 2.4GHz and 5GHz bands and also supports Bluetooth 5.2.

After the successful launch of Wi-Fi6 PCIe modules 8291N-PR (LGA package) and 8291M-PR (M.2 2230 Key E) last year, FN-Link did not hesitate any longer to develop a further module called 8266P-PR to extend its product family of QUALCOMM based Wi-Fi6 modules.

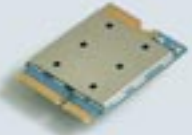
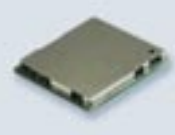
Just like 8291N-PR, 8266P-PR is offered in an LGA package. During development, the focus was placed on further optimizing of the form factor. The result is an unbelievable size of 20x15mm. If you think that this optimization must have been at the expense of performance, you will be proven wrong. In addition to MU-MIMO 2x2 and DBS, 8266P-PR masters HT160 on the 5GHz band, this means a maximum bandwidth of 160MHz. Together with the bandwidth of 40MHz (HT40) on the 2.4GHz band, 8266P-PR thus achieves an an-

MODEL NAME		8291M-PR	8291N-PR	8266P-PR
				
ORDERING PART NUMBER		FG8291MPRX-00	FG8291NPRX-00	FG8266PPRX-00/ FG8266PPRX-01
PLATFORM	Chipset	QCA-6391	QCA-6391	QCA-2066
	Interface Wi-Fi	PCIe 2.0, M.2 2230 Key E	PCIe 2.0	low Power PCIe 3.0
	Interface Bluetooth	UART, PCM	UART, PCM	UART, PCM
	Linux & Android / Mainline Driver	yes/TBD	yes/TBD	yes/no
	Windows	Windows 10	Windows 10	WIN7/WIN10
WIRELESS	Bluetooth Standard	V5.1, BLE	V5.1, BLE	V5.2, BLE
	Wi-Fi Standard	Wi-Fi6	Wi-Fi6	Wi-Fi6
	MIMO	MU 2x2	MU 2x2	MU 2x2
	Frequency	2.4GHz & 5GHz, DBS*	2.4GHz & 5GHz, DBS*	2.4GHz & 5GHz, DBS*
	Bandwidth	HT20/HT40/HT80	HT20/HT40/HT80	HT20/HT40/HT80/HT160
	Antenna Data Rate	1775Mbps	1775Mbps	2976Mbps
	Monitor Mode	yes	yes	yes
	Antenna Configuration	[BT,2G,5G]+[2G,5G]	[BT,2G,5G]+[2G,5G]	[BT,2G,5G]+[2G,5G]+(BT TX)**
	Antenna Type	2x IPEX	2x pins	2x pins / 3x pin
	Power Supply	3.3V	3.3V	3.3V
MODULE SPEC	Dimension (mm)	22x30	19.5x21.5	15x20
	Package	M.2 2230 Key E Module	Small SMT LGA	LGA
	Temperature Range	-30°C to 75°C	-30°C to 75°C	-30°C to 85°C
	Mounting	double side	single side	single side
	Carrier / QTY	Tray / 30	Tape & Reel / 500	Tape & Reel / 1500
	MOQ	1800	1500	3000
	Weight	2.6g	1.9g	0.8g
Certificate	CE, SRRRC	CE, SRRRC	CE	
DVK	no	yes	yes	
Comments		*Dual Band Simultaneous	*Dual Band Simultaneous	*Dual Band Simultaneous **Only FG8266PPRX-01 with 3pin Antennas



## Intelligent USB-C DC/DC POL10A

Designers and System Integrators looking to provide a USB-C powered peripheral or distributed supplies are well advised to use the new Ag7010, 10A POL Converter from SILVERTEL.

This surface mount module is perfectly suited for USB-C systems running on a tight power budget or distributed power systems requiring a POL converter, thanks to its high operating efficiency and high current delivery. Designed to provide a configurable 3.0-12.7V output from an 8-24V input, the module can be controlled and monitored through its on-board I2C interface (including integrated PMBus according to PMBus rev1.3 commands). The Ag7010 possesses a wide input voltage range and provides a non-isolated, low noise, low ripple output, ideally suited for USB-C Thunderbolt/Lightning applications. The module is available as a surface mount, ultra-small outline package, measuring only 37x14x7mm (LxWxH) which can be easily reflowed onto the host PCB, achieving tight thermal coupling and excellent thermal management.

The Ag7010 is equipped with **Under- and Over-Voltage Lock-Out**, **Output Enable**, **Over-Current** and thermal protection to provide a robust and reliable power supply solution. Operating over the industrial temperature range as standard and requiring few external components, a feature synonymous with SILVERTEL's range of power management modules, the transition from CAD to approved hardware is a very simple, low cost and risk-free step to take.

The new Ag7010 is now available from CODICO, as is a user-friendly Evaluation Board – EvalAg7010, which makes the design-in process much easier for development engineers.

A07

▶ André Ehlert, +49 89 130143811  
andre.ehlert@codico.com

A08

▶ Andreas Hanausek, +43 1 86305 131  
andreas.hanausek@codico.com



tenna data rate of 2976Mbps (2402Mbps on 5GHz and 574Mbps on 2.4GHz). In comparison, 8291N-PR and 8291M-PR only allow HT80 on 5GHz, resulting in a maximum antenna data rate of 1775 Mbps (1201Mbps on 5GHz and 574Mbps on 2.4GHz), which should still be sufficient for most applications, though.

Bluetooth has been upgraded from 5.1 to 5.2 and the temperature grade range has been extended from -30°C to 85°C, in comparison, the 8291 family supports -30°C to 75°C. 8266P-PR is offered in two versions with the following ordering part numbers:

- FG8266PPRX-00: 2x pin antenna
- FG8266PPRX-01: 3x pin antenna (the 3 pin is exclusively for BT TX)

All modules have in common that they are supported by Linux, Android and Windows. All features are listed in comparison in the table. For more information and an overview of other Wi-Fi6 module solutions, please visit our support page:

<https://downloads.codico.com/misc/AEH/FN-Link>





# TECHNOLOGICAL LEAP

## ...in Powering Systems with Isolated Signal Transmissions

Increasing standards for safety, power density and reliability demand the isolation of signals and power in industrial, medical and automotive applications, like industrial automation, medical examination equipment and electric vehicle battery management systems (BMS). Very often, interfaces like RS485, RS232, CAN, and USB require isolation.

**S**afety and reliability are crucial demands, in industrial, medical and automotive applications. Such systems often have high voltage blocks with sensors and power stages and low voltage blocks including the controls and human interfacing. In order to protect the low voltage parts of the systems from voltage spikes coming from the high voltage lines, the communication signals between the low voltage and the high voltage section

of the circuitry are getting isolated. The necessary isolated power supplies for the various parts of the system traditionally were cumbersome to implement. In order to make the design easier, MPS has taken micro isolated power supplies to a new level.

To improve power density and ease of design in the power electronics industry, MPS launched an

isolated DC/DC power module family, the MID06W0505A series, which are available in an SOIC-16 (10.3x10.3x2.5mm), chip-scale package (see Figure 1).

Traditional power modules are typically assembled by PCBs, capacitors, resistors, transformers, and ICs, and then encased in plastic shells. In contrast MPS uses a chip-level SOIC-16 package that is convenient for soldering, significantly reduces board space, improves reliability, and provides excellent performance.

With a traditional module, the potting glue is prone to aging because air bubbles can be mixed in during the potting process. Bubbles can be removed by placing the module in a box with a low atmospheric pressure to release the mixed air, but there is still a margin for error, so aging can still occur. This can lead to potting glue cracks and shell bulging. Even if most of the bubbles are extracted, the internal bubbles repeatedly expand and shrink during use, which also ages the pot-



Figure 1 and 2

range. The plug-in package is easily deformed, the pins are not able to achieve automatic welding, and the efficiency is low. Traditional modules can also be difficult to implement in space-constrained applications due to their height.

The MID06W0505A-3 addresses the shortcomings of traditional power modules with the following features:

- High pressure is used to encapsulate the plastic. This chip-level packaging system prevents bubbles from being created while improving reliability and pressure resistance
- $-40^{\circ}\text{C}$  to  $+125^{\circ}\text{C}$  operating temperature range
- Convenient, ultra-thin 2.5mm SOICW-16 package for SMT automation improves production efficiency and achieves a very thin profile to meet stringent height requirements.

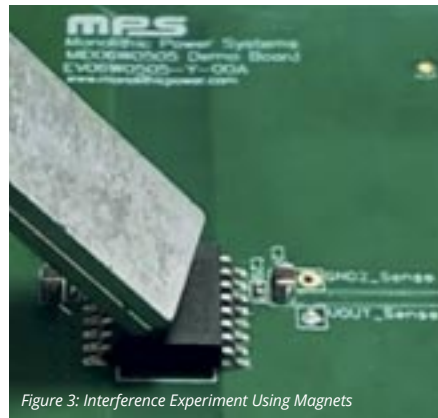

Figure 3: Interference Experiment Using Magnets

### Magnetic Field Immunity

When a product is exposed to a strong magnetic field, it can experience communication anomalies or even be burnt. These issues are often due to radiated or conducted magnetic interference.

Figure 3 shows an experiment in which magnets were placed above a module to create interference. Figure 4 shows the stable output of the MID06W0505A-3 while a magnet is above the power module.

These results contrast with traditional power modules, which can experience severe oscillations. For a traditional solution, a 5V output could overshoot to 7.8V, which could damage sensitive circuitry that is downstream from the power module (see Figure 5).

The abnormal output is due to open-loop control. When subjected to external interference, the module's internal circuit cannot be adjusted by close-loop regulation, and the output voltage ( $V_{\text{OUT}}$ ) fails to regulate. The MID06W0505A-3 uses advanced isolation feedback technology to provide real-time feedback on the external interference, which achieves closed-loop control and stabilizes  $V_{\text{OUT}}$ .

### Output Voltage Adjustments

In some cases with more stringent requirements for voltage regulation, a traditional power supply module has an unregulated  $V_{\text{OUT}}$  that fluctuates significantly with the input voltage ( $V_{\text{IN}}$ ) and load. In particular, when  $V_{\text{IN}}$  is at a maximum and there is no load,  $V_{\text{OUT}}$  fluctuates and rises to a substantial level. In this scenario, it is recommended to connect a dummy load at 10% of the rated load.

$V_{\text{OUT}}$  regulation can affect the subsequent stage circuit's system stability, which can result in relatively high static power consumption. The MID06W0505A-3 features internal closed-loop

ting glue. Aged potting glue significantly impacts the device by reducing the module's reliability. It can also lead to primary and secondary insulation failures, which can be dangerous for users.

In addition, traditional power modules generally operate in a narrow  $-40^{\circ}\text{C}$  to  $+85^{\circ}\text{C}$  temperature

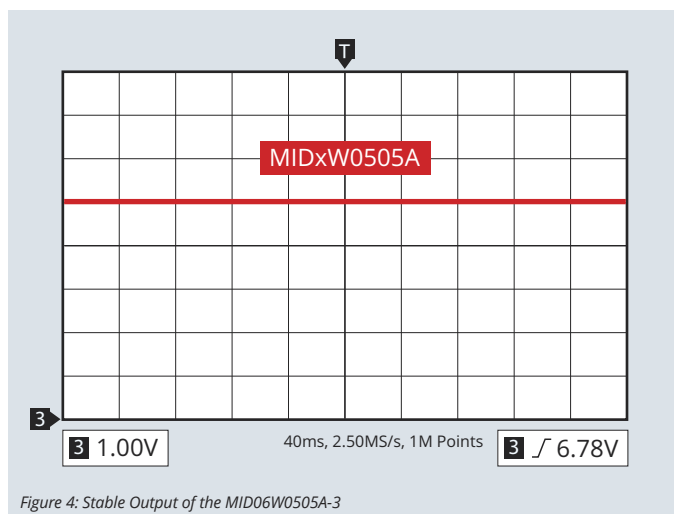

Figure 4: Stable Output of the MID06W0505A-3

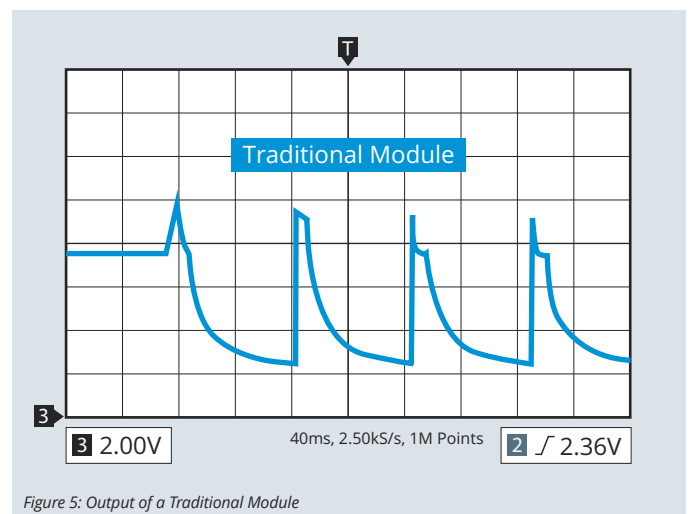

Figure 5: Output of a Traditional Module



**Load Regulation Comparison**

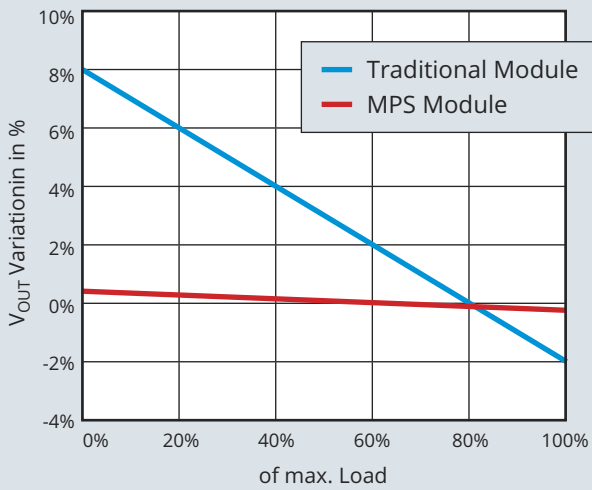

Figure 6: Load Regulation Comparison

**Linear Adjustment Rate Comparison**

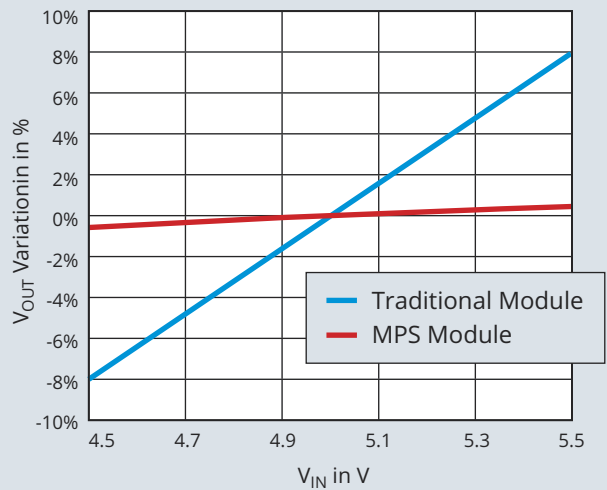

Figure 7: Linear Adjustment Rate Comparison

control, a stable  $V_{OUT}$ , no minimum load requirements, and a stable output while the static power consumption is low. Figure 6 shows a comparison between a traditional module's load regulation and the MID06W0505A-3's load regulation. Figure 7 shows a comparison between a traditional module's linear adjustment rate and the MID06W0505A-3's linear adjustment rate.

- protection (OTP)
- 3KVDC isolation voltage
- Meets CISPR32 Class B EMI test
- Certification according to IEC62368-1

Figure 8 shows the concise peripheral circuit of the MID06W0505A-3.

The MID family of isolated power modules currently comprises of 0.25, 0.4, 0.6 and 1W versions. Isolation barriers of 1,5KV and 3KV are available. Available output voltages are 3,3 and 5V.

A09

▶ Thomas Berner, +49 89 130143815  
thomas.berner@codico.com

The MID06W0505A-3 have a number of advantages over traditional isolated power modules. Its unique features, enhanced reliability and leading performance indicators include:

- 4.5V to 5.5V  $V_{IN}$  range
- 5V regulated  $V_{OUT}$  with excellent dynamic performance
- Typical 0.2% load regulation and 0.1% line regulation
- Up to 0.6W output rated power (1W optional)
- Supports continuous short-circuit protection (SCP), and over-temperature

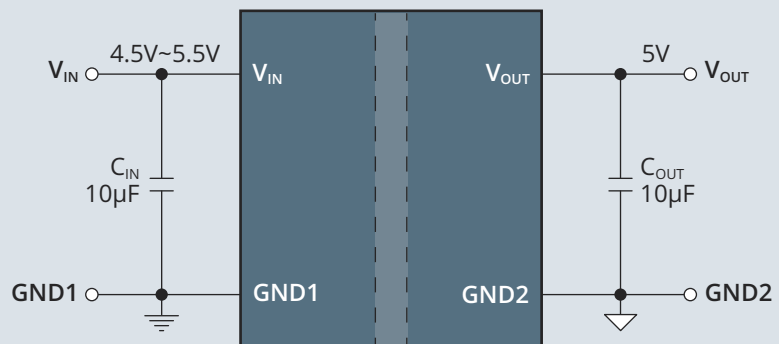

Figure 8: Peripheral circuit MID06W0505A-3



# electronica2022

## VISIT US!

The CODICO team would like to welcome you to electronica 2022! On more than 450m², you can expect insights into the latest technologies, advice at the highest level from our highly qualified team, Austrian hospitality and fun and excitement with a unique trade fair game! Visit us in hall C3 at stand 141 and meet our experts!

On the following pages you will find an overview of the CODICO employees who will be on-site. To arrange an appointment in advance, please get in touch with your personal contact directly.

### EXHIBITION HIGHLIGHTS

- EVSE
- Robotics
- Motion Control
- Audio
- CODICO Lab
- Automotive Cockpit & Infotainment
- Displays
- Home Automation & Heating
- Photovoltaic & New Energy

And so that you can recover a little from the hard everyday life at the fair, Austrian delicacies, a warm atmosphere and fun are also waiting for you!

### 2 LANE ART RACE TRACK

On the special occasion of electronica 2022, CODICO presents the multi-storey, handmade ART RACE TRACK by Austrian artist Martin Markeli. The artist is influenced by the time when the





model car racing track found its way into the affluent society of the 1970s, the car as a status symbol for young and old. The racetrack serves as a projection surface for the perception of a society that is geared towards speed and competition. The artist takes up these aspects in his staging of objects. He presents them in a landscape with fast cars and various symbolic figures from the consumer world. The artistic engagement takes place with the scene or the arena of car races. Markeli's racecourse is an artifact with which the artist breaks his interpretation of the spectacle down to a scale of 1:32 and tries to stimulate all the senses of the viewer. The focus is on the interaction between the work of art and the audience, which is established through a playful approach. Come and visit us! We are looking forward to seeing you!

PS: For a free 1-day ticket, please contact: [marketing@codico.com](mailto:marketing@codico.com)

### CEO





































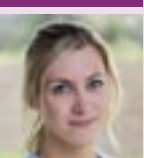

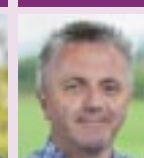

	
<b>KRUMPEL</b> Sven	<b>KRUMPEL</b> Karin
15.11. ●	15.11. ●
16.11. ●	16.11. ●
17.11. ●	17.11. ●
18.11. ●	18.11. ●

### MARKETING

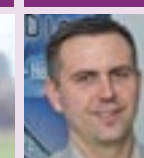
			
<b>PUNZET</b> Birgit	<b>EMERESZ</b> Monika	<b>NUHI</b> Erhida	<b>POJAR</b> Victoria
15.11. ●	15.11. ●	15.11. ●	15.11. ●
16.11. ●	16.11. ●	16.11. ●	16.11. ●
17.11. ●	17.11. ●	17.11. ●	17.11. ●
18.11. ●	18.11. ●	18.11. ●	18.11. ●

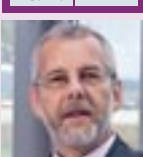
# CODICO Calendar

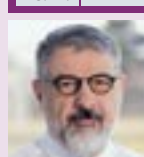
## ACTIVE COMPONENTS

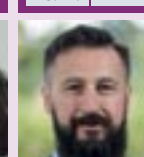
 <b>BARRANCO</b> Denis 15.11. <input checked="" type="checkbox"/> 16.11. <input checked="" type="checkbox"/> 17.11. <input checked="" type="checkbox"/> 18.11. <input checked="" type="checkbox"/>	 <b>BAZZACO</b> Leonardo 15.11. <input checked="" type="checkbox"/> 16.11. <input checked="" type="checkbox"/> 17.11. <input checked="" type="checkbox"/> 18.11. <input checked="" type="checkbox"/>	 <b>BERNER</b> Thomas 15.11. <input checked="" type="checkbox"/> 16.11. <input checked="" type="checkbox"/> 17.11. <input checked="" type="checkbox"/> 18.11. <input checked="" type="checkbox"/>	 <b>BJÖRKSTRAND</b> Peter 15.11. <input checked="" type="checkbox"/> 16.11. <input checked="" type="checkbox"/> 17.11. <input checked="" type="checkbox"/> 18.11. <input checked="" type="checkbox"/>	 <b>BUCHENBERG</b> Klaus 15.11. <input checked="" type="checkbox"/> 16.11. <input checked="" type="checkbox"/> 17.11. <input checked="" type="checkbox"/> 18.11. <input checked="" type="checkbox"/>	 <b>BUDKO</b> Vasily 15.11. <input checked="" type="checkbox"/> 16.11. <input checked="" type="checkbox"/> 17.11. <input checked="" type="checkbox"/> 18.11. <input checked="" type="checkbox"/>	 <b>CARMODY</b> Thomas 15.11. <input checked="" type="checkbox"/> 16.11. <input checked="" type="checkbox"/> 17.11. <input checked="" type="checkbox"/> 18.11. <input checked="" type="checkbox"/>	 <b>DEGENHART</b> Peter 15.11. <input checked="" type="checkbox"/> 16.11. <input checked="" type="checkbox"/> 17.11. <input checked="" type="checkbox"/> 18.11. <input checked="" type="checkbox"/>	 <b>EHLERT</b> André 15.11. <input checked="" type="checkbox"/> 16.11. <input checked="" type="checkbox"/> 17.11. <input checked="" type="checkbox"/> 18.11. <input checked="" type="checkbox"/>
 <b>FORTHUBER</b> Christian 15.11. <input checked="" type="checkbox"/> 16.11. <input checked="" type="checkbox"/> 17.11. <input checked="" type="checkbox"/> 18.11. <input checked="" type="checkbox"/>	 <b>FRÖMEL</b> Michael 15.11. <input checked="" type="checkbox"/> 16.11. <input checked="" type="checkbox"/> 17.11. <input checked="" type="checkbox"/> 18.11. <input checked="" type="checkbox"/>	 <b>GANGL</b> Christian 15.11. <input checked="" type="checkbox"/> 16.11. <input checked="" type="checkbox"/> 17.11. <input checked="" type="checkbox"/> 18.11. <input checked="" type="checkbox"/>	 <b>GIER</b> Ralf 15.11. <input checked="" type="checkbox"/> 16.11. <input checked="" type="checkbox"/> 17.11. <input checked="" type="checkbox"/> 18.11. <input checked="" type="checkbox"/>	 <b>GUSTAVSSON</b> Magnus 15.11. <input checked="" type="checkbox"/> 16.11. <input checked="" type="checkbox"/> 17.11. <input checked="" type="checkbox"/> 18.11. <input checked="" type="checkbox"/>	 <b>HANAUSEK</b> Andreas 15.11. <input checked="" type="checkbox"/> 16.11. <input checked="" type="checkbox"/> 17.11. <input checked="" type="checkbox"/> 18.11. <input checked="" type="checkbox"/>	 <b>JEITLER</b> Tamara 15.11. <input checked="" type="checkbox"/> 16.11. <input checked="" type="checkbox"/> 17.11. <input checked="" type="checkbox"/> 18.11. <input checked="" type="checkbox"/>	 <b>JAMSEK</b> Borut 15.11. <input checked="" type="checkbox"/> 16.11. <input checked="" type="checkbox"/> 17.11. <input checked="" type="checkbox"/> 18.11. <input checked="" type="checkbox"/>	 <b>KÄLLSTRÖM</b> Mikael 15.11. <input checked="" type="checkbox"/> 16.11. <input checked="" type="checkbox"/> 17.11. <input checked="" type="checkbox"/> 18.11. <input checked="" type="checkbox"/>
 <b>KOLLER</b> Wolfgang 15.11. <input checked="" type="checkbox"/> 16.11. <input checked="" type="checkbox"/> 17.11. <input checked="" type="checkbox"/> 18.11. <input checked="" type="checkbox"/>	 <b>KORNFIEHL</b> Johannes 15.11. <input checked="" type="checkbox"/> 16.11. <input checked="" type="checkbox"/> 17.11. <input checked="" type="checkbox"/> 18.11. <input checked="" type="checkbox"/>	 <b>KRANNICH</b> Tobias 15.11. <input checked="" type="checkbox"/> 16.11. <input checked="" type="checkbox"/> 17.11. <input checked="" type="checkbox"/> 18.11. <input checked="" type="checkbox"/>	 <b>LANG</b> Nicole 15.11. <input checked="" type="checkbox"/> 16.11. <input checked="" type="checkbox"/> 17.11. <input checked="" type="checkbox"/> 18.11. <input checked="" type="checkbox"/>	 <b>LEFANTI</b> Gabor 15.11. <input checked="" type="checkbox"/> 16.11. <input checked="" type="checkbox"/> 17.11. <input checked="" type="checkbox"/> 18.11. <input checked="" type="checkbox"/>	 <b>MAYER</b> Michael 15.11. <input checked="" type="checkbox"/> 16.11. <input checked="" type="checkbox"/> 17.11. <input checked="" type="checkbox"/> 18.11. <input checked="" type="checkbox"/>	 <b>MITIC</b> Ivan 15.11. <input checked="" type="checkbox"/> 16.11. <input checked="" type="checkbox"/> 17.11. <input checked="" type="checkbox"/> 18.11. <input checked="" type="checkbox"/>	 <b>PAYDA</b> Pawel 15.11. <input checked="" type="checkbox"/> 16.11. <input checked="" type="checkbox"/> 17.11. <input checked="" type="checkbox"/> 18.11. <input checked="" type="checkbox"/>	 <b>PINCHON</b> Jean-Baptiste 15.11. <input checked="" type="checkbox"/> 16.11. <input checked="" type="checkbox"/> 17.11. <input checked="" type="checkbox"/> 18.11. <input checked="" type="checkbox"/>
 <b>POLOVITZER</b> Lisa 15.11. <input checked="" type="checkbox"/> 16.11. <input checked="" type="checkbox"/> 17.11. <input checked="" type="checkbox"/> 18.11. <input checked="" type="checkbox"/>	 <b>POLZER</b> Andreas 15.11. <input checked="" type="checkbox"/> 16.11. <input checked="" type="checkbox"/> 17.11. <input checked="" type="checkbox"/> 18.11. <input checked="" type="checkbox"/>	 <b>REIS</b> Werner 15.11. <input checked="" type="checkbox"/> 16.11. <input checked="" type="checkbox"/> 17.11. <input checked="" type="checkbox"/> 18.11. <input checked="" type="checkbox"/>	 <b>ROČEK</b> Petr 15.11. <input checked="" type="checkbox"/> 16.11. <input checked="" type="checkbox"/> 17.11. <input checked="" type="checkbox"/> 18.11. <input checked="" type="checkbox"/>	 <b>ROSSI</b> Sergio 15.11. <input checked="" type="checkbox"/> 16.11. <input checked="" type="checkbox"/> 17.11. <input checked="" type="checkbox"/> 18.11. <input checked="" type="checkbox"/>	 <b>SANTOS</b> Jesus 15.11. <input checked="" type="checkbox"/> 16.11. <input checked="" type="checkbox"/> 17.11. <input checked="" type="checkbox"/> 18.11. <input checked="" type="checkbox"/>	 <b>SOMMER</b> Jürgen 15.11. <input checked="" type="checkbox"/> 16.11. <input checked="" type="checkbox"/> 17.11. <input checked="" type="checkbox"/> 18.11. <input checked="" type="checkbox"/>	 <b>STAHL</b> Achim 15.11. <input checked="" type="checkbox"/> 16.11. <input checked="" type="checkbox"/> 17.11. <input checked="" type="checkbox"/> 18.11. <input checked="" type="checkbox"/>	 <b>STANISZEWSKI</b> Robert 15.11. <input checked="" type="checkbox"/> 16.11. <input checked="" type="checkbox"/> 17.11. <input checked="" type="checkbox"/> 18.11. <input checked="" type="checkbox"/>
 <b>STRECKFUSS</b> Heike 15.11. <input checked="" type="checkbox"/> 16.11. <input checked="" type="checkbox"/> 17.11. <input checked="" type="checkbox"/> 18.11. <input checked="" type="checkbox"/>	 <b>STROHSCHENK</b> Joachim 15.11. <input checked="" type="checkbox"/> 16.11. <input checked="" type="checkbox"/> 17.11. <input checked="" type="checkbox"/> 18.11. <input checked="" type="checkbox"/>	 <b>TURDEANU</b> Nicodiu 15.11. <input checked="" type="checkbox"/> 16.11. <input checked="" type="checkbox"/> 17.11. <input checked="" type="checkbox"/> 18.11. <input checked="" type="checkbox"/>	 <b>TYMOSCH</b> Ralf 15.11. <input checked="" type="checkbox"/> 16.11. <input checked="" type="checkbox"/> 17.11. <input checked="" type="checkbox"/> 18.11. <input checked="" type="checkbox"/>	 <b>URBAN</b> Markus 15.11. <input checked="" type="checkbox"/> 16.11. <input checked="" type="checkbox"/> 17.11. <input checked="" type="checkbox"/> 18.11. <input checked="" type="checkbox"/>	 <b>ZANGGER</b> Viorica 15.11. <input checked="" type="checkbox"/> 16.11. <input checked="" type="checkbox"/> 17.11. <input checked="" type="checkbox"/> 18.11. <input checked="" type="checkbox"/>	 <b>ZUCKMANTEL</b> Marco 15.11. <input checked="" type="checkbox"/> 16.11. <input checked="" type="checkbox"/> 17.11. <input checked="" type="checkbox"/> 18.11. <input checked="" type="checkbox"/>		



# electronica2022

electronica 2022  
Messe München | November 15-18  
VISIT CODICO @ BOOTH C3.141

## PASSIVE COMPONENTS

 <b>ANDRÁ</b> Ines 15.11. ● 16.11. ● 17.11. ● 18.11. ●	 <b>BLAHA</b> Michael 15.11. ● 16.11. ● 17.11. ● 18.11. ●	 <b>DADATI</b> Matteo 15.11. ● 16.11. ● 17.11. ● 18.11. ●	 <b>DRAZIC</b> Srecko 15.11. ● 16.11. ● 17.11. ● 18.11. ●	 <b>EGGER</b> Thomas 15.11. ● 16.11. ● 17.11. ● 18.11. ●	 <b>GASPARONI</b> Adriano 15.11. ● 16.11. ● 17.11. ● 18.11. ●	 <b>GEBHART</b> Sebastian 15.11. ● 16.11. ● 17.11. ● 18.11. ●	 <b>GEITZENAUER</b> Arnold 15.11. ● 16.11. ● 17.11. ● 18.11. ●	 <b>HEINEN</b> Sven 15.11. ● 16.11. ● 17.11. ● 18.11. ●
 <b>IKUNO</b> Yasunobu 15.11. ● 16.11. ● 17.11. ● 18.11. ●	 <b>JELL</b> Thomas 15.11. ● 16.11. ● 17.11. ● 18.11. ●	 <b>KUUSRAINEN</b> Pasi 15.11. ● 16.11. ● 17.11. ● 18.11. ●	 <b>LAMCHAOURI</b> Samir 15.11. ● 16.11. ● 17.11. ● 18.11. ●	 <b>MENGHINI</b> Michaela 15.11. ● 16.11. ● 17.11. ● 18.11. ●	 <b>MORAVCIKOVA</b> Lenka 15.11. ● 16.11. ● 17.11. ● 18.11. ●	 <b>MOSTLER</b> Bernadette 15.11. ● 16.11. ● 17.11. ● 18.11. ●	 <b>NOVAK</b> Jakub 15.11. ● 16.11. ● 17.11. ● 18.11. ●	 <b>ORTOLAN</b> Florence 15.11. ● 16.11. ● 17.11. ● 18.11. ●
 <b>PLÄSSER</b> Dirk 15.11. ● 16.11. ● 17.11. ● 18.11. ●	 <b>ROSA</b> Antonello 15.11. ● 16.11. ● 17.11. ● 18.11. ●	 <b>SCALICK</b> Rainer 15.11. ● 16.11. ● 17.11. ● 18.11. ●	 <b>SCHMID</b> Markus 15.11. ● 16.11. ● 17.11. ● 18.11. ●	 <b>SCHMID</b> Tim 15.11. ● 16.11. ● 17.11. ● 18.11. ●	 <b>STEIDL</b> Oliver 15.11. ● 16.11. ● 17.11. ● 18.11. ●	 <b>TRIMMEL</b> Roland 15.11. ● 16.11. ● 17.11. ● 18.11. ●	 <b>VOSS</b> Dirk 15.11. ● 16.11. ● 17.11. ● 18.11. ●	 <b>WALKER</b> Jürgen 15.11. ● 16.11. ● 17.11. ● 18.11. ●

 <b>WEISS</b> Wolfgang 15.11. ● 16.11. ● 17.11. ● 18.11. ●	 <b>ZABEHLICKY</b> Vanessa 15.11. ● 16.11. ● 17.11. ● 18.11. ●
--	--

## CONNECTORS

 <b>DE CHIRICO</b> Ezio 15.11. ● 16.11. ● 17.11. ● 18.11. ●	 <b>DERKITS</b> Romana 15.11. ● 16.11. ● 17.11. ● 18.11. ●	 <b>DÜZ</b> Ferhat 15.11. ● 16.11. ● 17.11. ● 18.11. ●	 <b>GOTZ</b> Claudia 15.11. ● 16.11. ● 17.11. ● 18.11. ●	 <b>HALLER</b> René 15.11. ● 16.11. ● 17.11. ● 18.11. ●	 <b>KÄMPFER</b> Thomas 15.11. ● 16.11. ● 17.11. ● 18.11. ●
---	--	--	--	---	--

## ORDER

 <b>KRONFELLNER</b> Michaela 15.11. ● 16.11. ● 17.11. ● 18.11. ●	 <b>NERVO</b> Matteo 15.11. ● 16.11. ● 17.11. ● 18.11. ●	 <b>STUMMER</b> Katharina 15.11. ● 16.11. ● 17.11. ● 18.11. ●	 <b>ZUSKIC</b> Stefan 15.11. ● 16.11. ● 17.11. ● 18.11. ●
--	--	---	---

 <b>NIX</b> Christian 15.11. ● 16.11. ● 17.11. ● 18.11. ●	 <b>REITERER</b> Julia 15.11. ● 16.11. ● 17.11. ● 18.11. ●	 <b>SCHWIERTZ</b> Michaela 15.11. ● 16.11. ● 17.11. ● 18.11. ●	 <b>SICHTAR</b> Christian 15.11. ● 16.11. ● 17.11. ● 18.11. ●	 <b>STROBL</b> Gerhard 15.11. ● 16.11. ● 17.11. ● 18.11. ●
---	--	--	---	--





# NEW PARTNER

## Snap-In Type E-Caps Comes in a Miniaturized Size



RUBYCON announced 4 new series of Snap-In type electrolytic capacitors: MXT, VXT, HXH and HXK suitable for all applications. With this update, RUBYCON maintains its technological edge in the market. To this day, no competitors have been able to match such specifications.

First, let's have an overview of RUBYCON's easily understandable Snap-In series definition:

**Meaning of the first 2 letters:**

- US series: 85°C/3,000h
- MX series: 105°C, 2,000 bis 3,000h
- VX series: 105°C, 5,000h
- HX series: 105°C, 3,000 bis 5,000h (high ripple current type)
- GX series: 105°C, 7,000h
- NX series: 105°C, 10,000h
- TH series: 125°C, 2,000h

**Meaning of the last letter:**

From large size C > G > H > K to smaller size: (i.e. MXC > MXG > MXH > MXK).

**New series from RUBYCON**

- MXT series: 105°C, 3,000h
- VXT series: 105°C, 5,000h
- HXH series, HXK series: 105°C, 3,000 to 5,000h (depends on usage)

Until today, the last letter »K« (like MXK or VXK) was the smallest and highest specification series on the market. RUBYCON has now announced a new last letter »T«, introducing the MXT (105°C, 3,000h) and VXT series (105°C, 5,000h).

At the same time, RUBYCON also announced the new HX, HXH and HXK series, which has an optional rated ripple current for each 3,000h and 5,000h lifetime. These series are mainly targeting

automotive applications, especially On-Board Chargers, which require a very high ripple current. Moreover, the category temperature is set at -40 to 105°C as a standard.

**Target applications**

- Suitable for applications requiring high voltage, capacitance and current (industrial, automotive)
- Photovoltaic inverters for solar energy
- 5G small cells
- EVSE (EV charging stations, On-Board Chargers, etc.)
- Fanless power supplies

**RUBYCON is willing to customize**

please check the detailed size, capacitance and ripple current chart in the RUBYCON catalogues and on the website. In the detail charts, you might find some sizes or values that are identical with bigger size series (like HXH or VXK) and small-

Key features of the new series	
<b>MXT SERIES (105°C, 3,000h)</b>	
Category temperature range	-25 to 105°C (optional -40 to 105°C)
Voltage	400, 420 and 450V
Capacitance	150 to »1,500µF«
Rated ripple current	0,92 to 3,03Arms/120Hz, 105°C
Size	ø22x25 to ø35x60mm
<b>VXT SERIES (105°C, 5,000h)</b>	
Category temperature range	-25 to +105°C (optional -40 to 105°C)
Voltage	400, 420 and 450V
Capacitance	150 to 1.200µF
Rated ripple current	0,89 to 2,88Arms/120Hz, 105°C
Size	ø22x25 to ø35x55mm
<b>HXH SERIES (105°C, 5,000h)</b>	
Category temperature range	-40 to 105°C
Voltage	400, 420 and 450V
Capacitance	82 to 1.000µF
Rated ripple current	1,07 to 4,75Arms/120Hz, 105°C for 3,000h lifetime 0,75 to 3,36Arms/120Hz, 105°C for 5,000hr lifetime
Size (ø × High)	ø20x25 to ø35x60mm
<b>HXK SERIES (105°C, 5,000h)</b>	
Category temperature range	-40 to 105°C
Voltage	400, 420 and 450V
Capacitance	82 to 1.000µF
Rated ripple current	1,07 to 4,76Arms/120Hz, 105°C for 3,000h lifetime 0,75 to 3,37Arms/120Hz, 105°C for 5,000hr lifetime
Size (ø × High)	ø20x25 to ø35x60mm

ler size series (like HXK or VXT). Those values are correct but please do not consider these specifications to be the limits. Because RUBYCON follows standard rules, it sets the chart from the standard values which JIS uses. For instance, the capacitance value steps are 270µF, 330µF, 470µF, 560µF, etc. That is why charts do not show values between those standards.

This means that RUBYCON has still some room for higher specification. If the bigger size series and smaller size series show the same size, capacitance and rated ripple current, the smaller size series always has more margin to customize or upgrade the specification.

RUBYCON and CODICO are always willing to support and help you to find the right solution.

All series are available for samples and mass production. If you wish to have more information, please contact:

P01

➤ Yasunobu Ikuno, +43 1 86305276  
yasunobu.ikuno@codico.com

Comparison of all 4 series			
<b>Example 1: Rated voltage 450V, lifetime 3,000h, capacitance 330µF, ø25mm</b>			
SERIES	SIZE	RATED RIPPLE CURRENT (120Hz, 105°C)	PART NUMBER
MXK	ø25x45mm	1,85Arms	400MXK330MEFCSN25x45
MXT (new)	ø25x35mm (22% smaller)	1,49Arms	400MXT330MEFCSN25x35
HXH (new)	ø25x45mm	2,56Arms (38% higher)	400HXH330MSPASN25x45
<b>Example 2: Rated voltage 450V, lifetime 5,000h, ø35x45mm</b>			
SERIES	CAPACITANCE	RATED RIPPLE CURRENT (120Hz, 105°C)	PART NUMBER
VXK	820µF	2,37Arms	450VXK820MEFCSN35x45
VXT (new)	1.000µF (22% higher)	2,51Arms (6% higher)	450VXT1000MEFCSN35x45
HXH (new)	680µF	2,63Arms (11% higher)	450HXH680MSPASN35x45
HXK (new)	820µF	2,75Arms (16% higher)	450HXK820MSPASN35x45
<b>Example 3: Rated voltage 450V, lifetime 5,000h, capacitance 470µF, ø30mm</b>			
SERIES	SIZE	RATED RIPPLE CURRENT (120Hz, 105°C)	PART NUMBER
VXK	ø35x35mm	1,84Arms	450VXK470MEFCSN35x35
VXT (new)	ø35x30mm (14% smaller)	1,64Arms	450VXT470MEFCSN35x30
HXH (new)	ø35x35mm	2,09Arms (14% higher)	450HXH470MEFCSN35x35

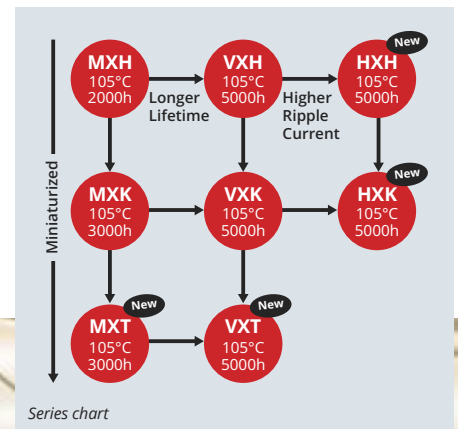

# EVOLUTION

## ...of the TXC ThermoSym OXCO

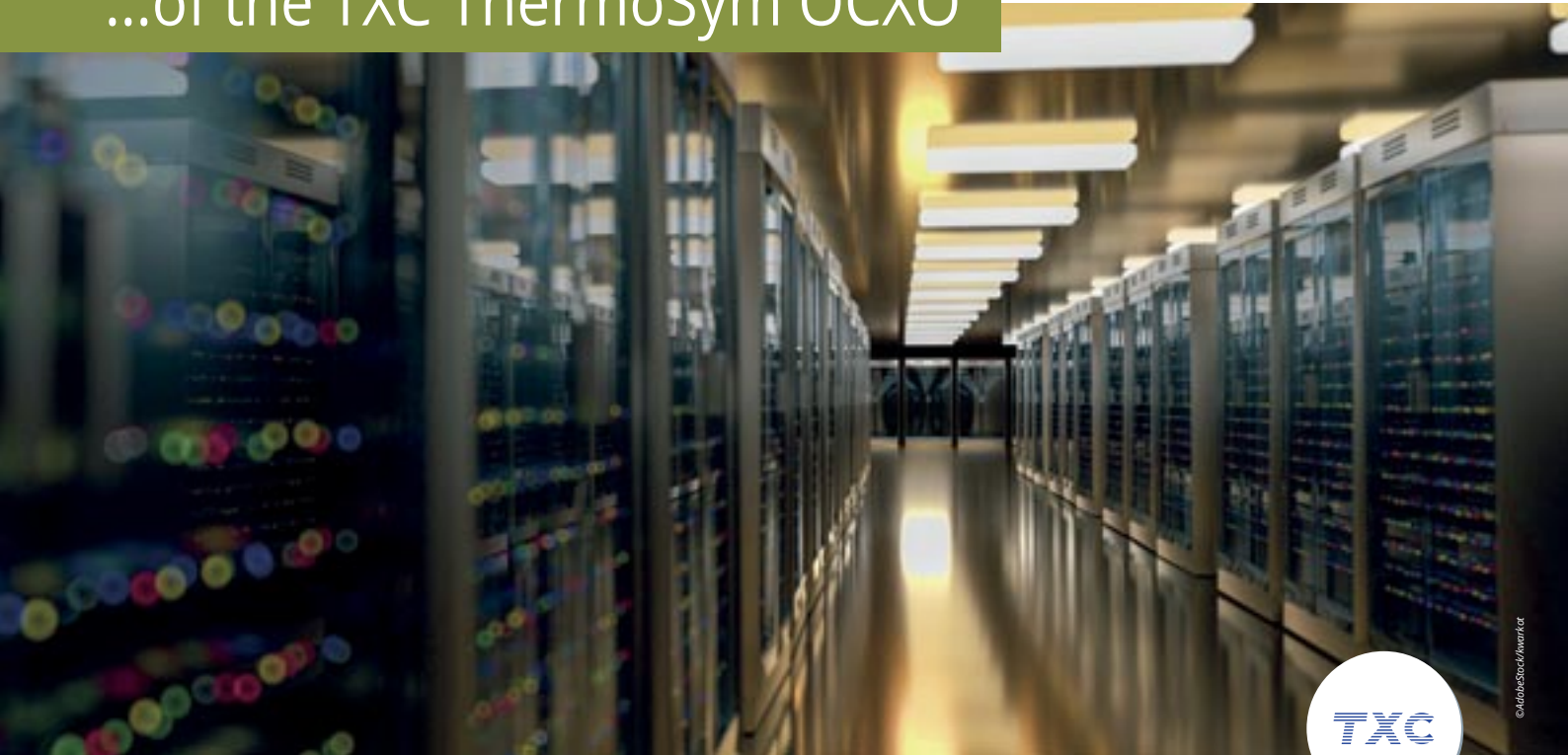

© AdobeStock/Amir123

More stable, or more miniaturized. TXC has developed its patent ThermoSym OXCO to another level. ThermoSymEros and ThermoSymChronos will be the new solution for your 5G developments.

### ThermoSym OXCO

TXC develops OXCO under its patent name ThermoSym. This OXCO patent uses its own-developed thermal symmetry technology, which puts the heater in the middle between the IC and the crystal blank for a symmetrical thermal distribution. Thanks to this structure, the OXCO can maintain the temperature of both the temperature compensation IC and the crystal blank as close as possible for greater accuracy.

Another highlight of ThermoSym is TXC's own developed SC-cut crystal. OXCO frequently uses a SC-cut crystal because of its very high accuracy at oven temperature, which translates into a better manageable overall frequency stability. In addition, TXC's SC-cut crystal has a higher Q-factor and better short-term and long-term aging characteristics.

Based on this technology, TXC has now developed two new different variants, ThermoSymEros and ThermoSymChronos, which they believe allow them to cover all demands for 5G applications.

### ThermoSymEros

ThermoSymEros is the ultra-miniaturized OXCO solution offering sizes 5.0×3.2mm (OK series) and 7.0×5.0mm (OH series). Even at such small sizes, their excellent performances enable them to meet the requirements of 5G and optical network applications. It also presents advantages over today's TCXOs in either quartz-based or MEMS-based products. The ThermoSymEros

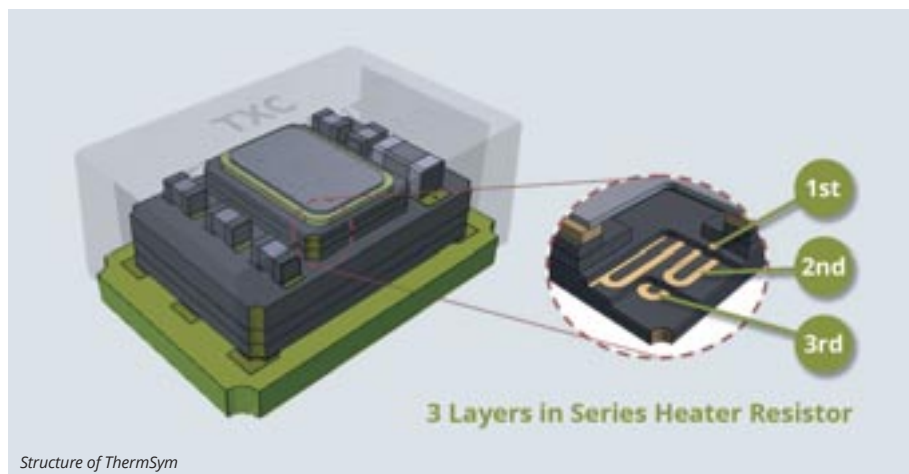



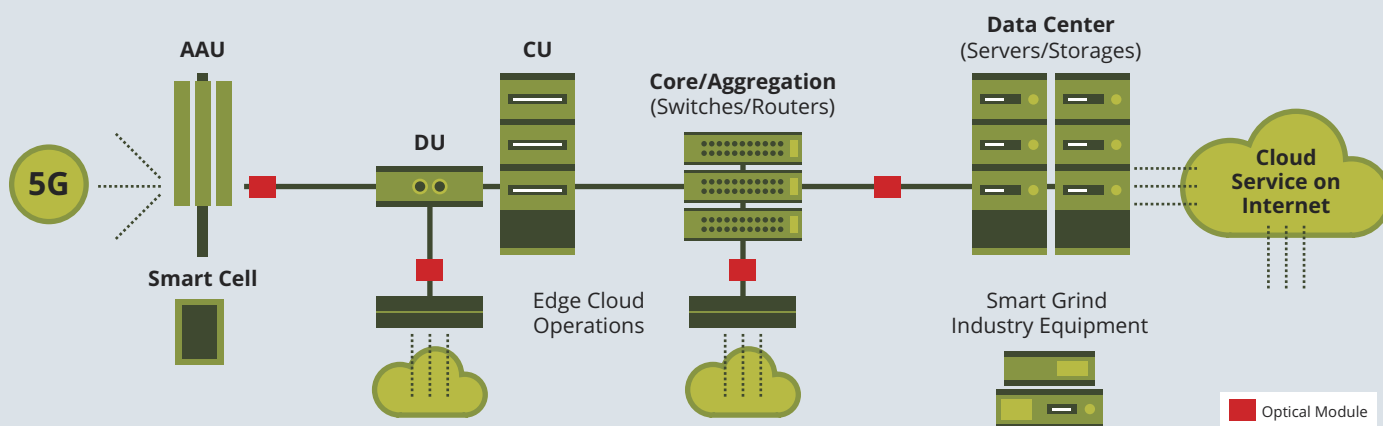

5G-Network

Features ThermoSymEros		Features ThermoSymChronos	
Size	7050 (OH series), 5032 (OK series)	Size	1409 (OE series), 9070 (OG series), 7050 (OH series)
Frequency stability over temperature	<±20ppb over -40 bis 95°C	Frequency stability over temperature	<±3ppb over -40 bis 85°C <±1ppb over 0 bis 70°C
Phase noise performance	<-160dBc/Hz at 10MHz carrier	Phase noise performance	ppt level over ±5% Vcc
Long-term stability	<±2ppm over 10 years	Long-term stability	<±40ppt over -40 bis 85°C
Power consumption	400mW at room temperature	Power consumption	<-160dBc/Hz at 10MHz carrier
Warm-up time	10s für <±20ppb stability	Warm-up time	Typical ±0,6ppb/day
Low G-sensitivity	<±1ppb/g		

series delivers a better timing performance, such as frequency stability over temperature, phase noise, aging, holdover, etc. ThermoSymEros can supply an excellent external reference clock connection to PLL chipsets used for timing synchronization standards related to SyncE, IEEE1588 (PTP), and SONET/SDH in high-speed network infrastructures.

**Benefits**

- Fully compatible with the requirements of 5G applications
- Enables Remote Radio Head (RRH) PLLs to use a single mode (reference) to meet both wander and jitter performance for network synchronization and air interface requirements
- Supports phase holdover requirement when synchronization sources are lost in some scenarios
- Strict environment support such as outdoor consideration

**Applications**

- 5G infrastructure (Remote Radio Unit (RRU)/ Remote Radio Heads (RRH), Small Cells, Base Stations, etc.)
- High speed optical networks (SyncE, IEEE1588, and SONET/SDH)
- Microwave transmission system applications
- Other high accuracy applications

Moreover, a 3.2x2.5mm size is being considered for the future. TXC aims at developing this size in 2023.

**ThermoSymChronos**

ThermoSymChronos is the ultra-stable OCO solution with a stability that can keep the ppt (parts-per-trillion) level in a miniature package. This excellent reference clock supports stratum 3E level for timing synchronization in 5G network infrastructure, Core Network, Advanced Switches, Advanced Routers, Internet Data Centers (IDC), etc.

Based on the ThermoSym OCO technology, ThermoSymChronos supports a new generation chipset using advanced oven control technology to achieve excellent performance.

As mobile network data traffic grows, the greater becomes the necessity for timing synchronization in the 5G network infrastructure. The correct time clock will assist high-speed data transmission in which in return requires higher network bandwidth and lower latencies.

The ThermoSymChronos series can fully support an excellent timing solution performance of less than ±1ppb stability over temperature to meet timing synchronization standards related to stratum 3E level and holdover requirements.

**Benefits**

- Smallest package size for a ppt-level stability oscillator
- Fully compliant with the requirements of stratum 3E specification and Telecom Boundary Clocks (T-BC) Class C and Class D
- Supports a few hours phase holdover requirement when synchronization sources are lost in some scenarios.
- Resilient to airflow interference

**Applications**

- 5G infrastructure  
RU (Radio Unit)/AAU (Active Antenna Unit), DU (Distributed Unit), CU (Centralized Unit), Small Cells, Base Stations/Base Band Unit (BBU), etc.
- Internet Data Centers (Servers, Storages, etc.)
- PTP (Precision Time Protocol) enables advanced Ethernet routers and switches
- Other high accuracy applications

TXC is ready to provide both ThermoSymEros and ThermoSymChronos technologies to customers looking for high-accuracy timing clock source. If you are interested in this topic and wish to obtain more information, please contact:

P02

▶ Yasunobu Ikuno, +43 1 86305276  
yasunobu.ikuno@codico.com



# EXHIBITION HIGHLIGHT

## RUBYCON's PMLCAP Bar for EVs



RUBYCON's polymer multilayer capacitor PMLCAP is extending the rated voltage to 500V. The significant series is now available and targets existing snubber capacitor applications, which are classically designed with film and ceramic capacitors.

### MH series as snubber capacitor

First introduced in our Impulse 01-2022 issue, MH is the first series rated for 500V operation, while maintaining the PMLCAP advantages. The MH series' target is to replace today's snubber capacitors through advantages like space-saving design (90% smaller than film), no DC-bias, and no short-circuit risk.

#### BASIC SPECS OF MH SERIES

- Temperature range: -55°C to +125°C
- Rated voltage/capacitance: 250V/1.0µF and 500V/0.22µF
- Size: 8271 (8.2×7.1×1.8mm)
- Voltage proof: 150% of rated voltage (1min)
- Insulation resistance: 300MΩ/µF or more
- Humidity resistance: 40°C, 95% RH, 500h
- Samples and MP: Available upon request

### Power PMLCAP to replace power film capacitor



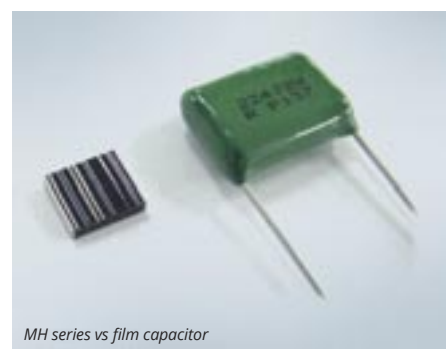

The MH series is just one milestone in high voltage PMLCAP. RUBYCON's ultimate target is to have much higher voltage and higher capacitance to replace power film capacitors used inside electric vehicle inverters.

For those high voltage, high-current applications, large box-size film capacitors are currently used. PMLCAP technology generally offers the possibility to replace film capacitors and achieve miniaturization down to 10%. If PMLCAP reaches such high voltage in the future, the estimated size and weight reduction will be around 90%. With this size and weight, driving efficiency will improve dramatically.

The actual challenge of PMLCAP technology is the improvement of the voltage gradient. Voltage gradient ( $\mu\text{m}$ ) shows simply how much voltage can be applied on dielectric material per thickness. Today, film capacitors using polypropylene (PP) as the main material have a maximum voltage gradient of  $250\text{V}/\mu\text{m}$ , which was improved by changing the dielectric constant and evolving the fuse pattern. Though there is still room for technological improvement, polypropylene has basic physical characteristics such as a dielectric constant of 2.2 (30% less than PML) and a  $160^\circ\text{C}$

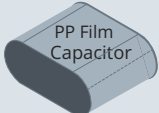

MH series vs film capacitor

Voltage Gradient [V/μm]	250	200	250	275	300
Element Image					
Volume Ratio (With PP Film Capacitor as 100%)	Permittivity (PP) 2.1		Permittivity (PML) 2.9		
	100%	125%	80%	60%	56%
Volume comparison of 500V product		Achieved		Under Development	

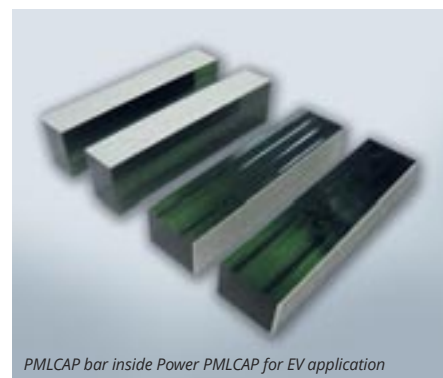

melting point. These properties will not change in the future.

PMLCAP has a big advantage over polypropylene's physical characteristics. PMLCAP's dielectric element will not become softer or melt up to a decomposition temperature of 400°C. In addition, PMLCAP's dielectric vapor deposition process does not present the risk of micro-pinholes such as those occurring in PP film capacitor production. By improving the voltage gradient using these advantages, RUBYCON has now achieved a 250V/μm design, with room for further improvement in the future.

PMLCAP presents another advantage, by introducing a thinner dielectric layer. The thickness of the polypropylene film is about 2.0μm, and it is difficult to make it even thinner. So even if film capacitors are improving the voltage gradient, or if the required voltage in the market are declined, film capacitors will never be smaller than today.

It is currently possible to reduce the dielectric constant of PMLCAP to a minimum of 0.2μm, and its size can be changed depending on the rated voltage required. PMLCAP thus offers the flexibility and advantages allowing it to be adapted to future requirements.

Today, the main difficulty faced with PMLCAPs is the production process. The current vapor deposition machine cannot automatically produce the high voltage type. Therefore, RUBYCON can consult with customers on high voltage projects from a technical point of view, but it cannot yet provide samples or details in the short term.

RUBYCON is planning to introduce a new vapor deposition machine in early 2023. This machine will be designed for automatic production of the high-voltage type PMLCAPs. With this machine

at its disposal, RUBYCON will be able to discuss more details with you and provide you with samples for testing. If you are interested in this topic and wish to receive more information, please contact Yasunobu Ikuno.

**Visit us @electronica 2022 – Hall C3, Booth 141**

We will be exhibiting this future high-voltage PMLCAP bar aiming to replace today's power film capacitors at our electronica2022 booth. This is

the first time that the bar will be shown outside Japan. This bar is now considered one unit, and you can make parallel/serial connections inside your capacitor module. The bar's dimensions are 16.8×64×15mm, with a specification of 500V and 50μF. RUBYCON can currently also provide 800V and 30μF at the same size.

Visit CODICO's booth at electronica2022 and take a look at it in person!

P03

▶ Yasunobu Ikuno, +43 1 86305276  
yasunobu.ikuno@codico.com

**APPLICATIONS**

- All snubber circuit
- Industrial inverters (low and high voltage)
- EV inverters

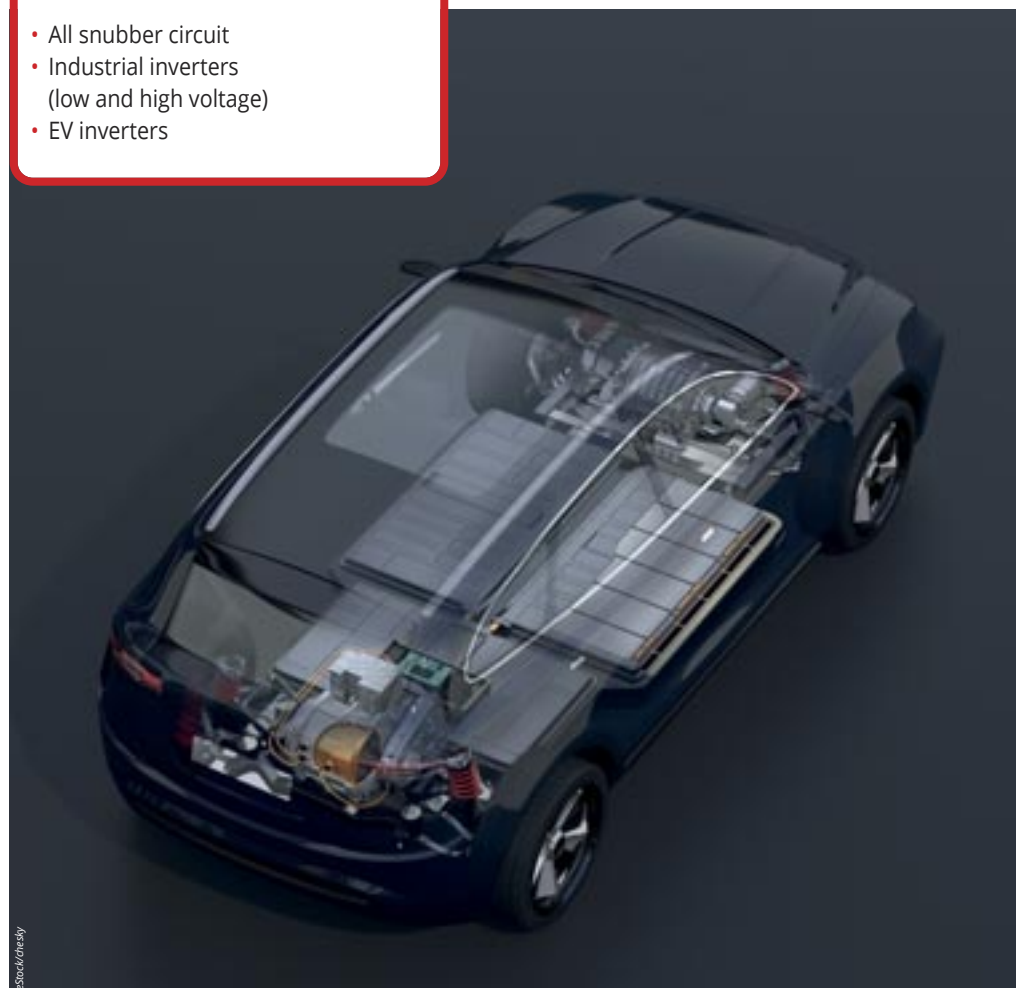

©Adeco/stock/creaky



# OSCILLATOR FLEXIBILITY



©AdobeStock/Georgij

The new »Molded Oscillator« by KDS is part of KDS's future strategy to be flexible regarding design and supply. It's a topic the entire market feared due to recent allocation.

## Let's update on Arkh.3G

In 2017, KDS developed a new technology called Arkh.3G. This was an interesting technology because of two particular characteristics:

- It uses only quartz crystal for both the oscillation and the packaging part
- It has an ultra small packaging (1.0×0.8mm) with the lowest height in the market (0.18mm max.)

Current target applications of Arkh.3G are wireless earphones, wireless modules, and hearing aid devices. Moreover, the characteristics of Arkh.3G offer future perspectives for crystal components, allowing timing devices to be embed-

ded into chipsets or other components. If you are interested in this Arkh.3G technology, please check issue 02-2017 of our Impulse magazine, or contact your CODICO supplier.

## Molded oscillators

KDS has now developed a new solution as the next step in timing device embedding. The so-called »molded oscillator« is the same as a standard crystal oscillator, containing the oscillation circuit in one package. The main difference is that the »molded oscillator« houses all ready-made products such as crystal unit, IC, and balancing capacitors together. When manufacturing the »molded oscillator«, standard epoxy (PCB) is used as the base for the package.

An epoxy base allows an easy change of layouts to mount the IC inside, and also to adapt the foot patterns to meet customers requests. The product cover is resin, but the components inside are ready-made products. The resin cover is mainly used to hide the component inside and has no impact on the hermetic sealing of the whole unit.

Two types of crystal units are used inside. For MHz requirements, Arkh.3G is used because of its size and low height. For 32,768kHz, a ceramic-packaged tuning fork type DST1610A is molded. KDS DST1610A is very competitive in the market, therefore it also offers a benefit from the cost point of view.

© Adobe Stock/Ornlow

### 1. Features of large-size SPXO

Available size	7,0x5,0mm, 5,0x3,2mm
Frequency	Up to 160MHz
Supply voltage	1,8 to 3,3V (5,0V is under consideration)
Frequency stability	±30ppm (-20 to +70°C), ±50ppm (-40 to +85°C)
Other	A programmable oscillator (using a PLL circuit inside) is also available.
Availability	Samples are already available, Mass production from 2023

#### The new molded oscillators are targeting the following three requirements:

1. Supply large-sized, discontinued oscillators (such as 7.0x5.0mm or 5.0x3.2mm)
2. Flexibility to overcome material shortage
3. Flexibility regarding new crystal oscillator designs (like different oscillators, RTC modules, etc.)

#### 1. Supply large-sized, discontinued oscillators

It must be pointed out that our major policy – and that of KDS – will remain unchanged. By taking the future supply situation into account, we will suggest the most available size of each product for our customer's projects. From today's point of view, this will be 2.0x1.6mm (2016) for MHz inquiries.

Not being able to support customers when their supplier suddenly discontinued old large-sized package crystals has been disconcerting. CODICO and KDS will not leave customers in the dark regarding market trends, but unfortunately there are some suppliers and distributors who do not assume a long-term responsibility for their customer's project.

With KDS's molded oscillators, we are now able to offer alternatives to large-sized discontinued oscillators like 7.0 x 5.0mm (7050) or 5.0 x 3.2mm (5032). These sizes are mostly phased out in today's market because of lower demand, making it difficult to find a ceramic base supplier.

KDS's »molded oscillator« does not use a ceramic base. An epoxy base can be flexible in adapting to a customer's layout design, which often cannot change.

#### 2. Flexibility to overcome material shortage

»Molded oscillators« can also be downsized to 2.0x1.6mm because of the molded crystal Arkh.3G inside. This offers a benefit especially during allocation period. One of the reasons for tight allocation in recent times was the shortage in ceramic base material, provided only by a few reliable suppliers.

KDS can continue the supply of its »molded oscillators« even during a ceramic base shortage. The epoxy base and resin cover are easy to procure. The original crystal unit is Arkh.3G, whose package is also an in-house quartz material. KDS has easier procurement access.

Easier procurement also means that the material cost is lower and more stable. Moreover, the company can also reduce costs by focusing on standard frequencies.

#### 3. Flexibility regarding new crystal oscillator designs

The majority of crystal oscillator demand basically involves SPXO (simple package crystal oscillator) with CMOS output and TCXO used in mobile phones and GNSS. This demand dominates the volume of crystal oscillator usage. Nevertheless, market demand varies.

You will need OCXOs and VCXOs for network infrastructures. Differential output oscillators and even multi-output mode oscillators will be needed. The functions will depend on the oscillator's internal IC. Each package must be precisely designed to connect the various individual ICs with the crystal blank inside. Crystal suppliers must invest in the packages to meet the individual requirements.

What if the »molded oscillator« takes over those requirements? Of course, it is necessary to develop the internal oscillation circuit, but the package designs to mount IC and connect to foot patterns will be more flexible and therefore it is easier to adapt to new additional ICs.

### 2. Features of the new 2016-size SPXO

Available size	2,0x1,6mm
Frequency	Up to 80MHz 12 frequencies set as standard frequencies: 10MHz / 12MHz / 20MHz / 24MHz / 25MHz / 27MHz / 33,333MHz / 40MHz / 48MHz / 50MHz / 54MHz / 66,666MHz
Supply voltage	1,8 to 3,3V (5,0V is under development)
Frequency stability	±30ppm (-20 to +70°C), ±50ppm (-40 to +85°C)
Other	A programmable oscillator (using a PLL circuit inside) is also available.
Availability	Samples and MP are already available

### 3. Features of DD3225TS

Digital temperature compensated type	
Precision	±5ppm -40 to +85°C (monthly difference: ±13s) ±7ppm -40 to +105°C (monthly difference: ±18s)
Operation voltage	+1,5 to +5,5V temperature-compensated operation +1,3 to +5,5V Clock
Current consumption	0,3µA typ.
Clock function	hour, minute, second
Output	I2C-BUS* serial interface

\*I2C-Bus is a registered trademark of NXP Semiconductors



Arkh.3G



DD3225TS



Molded Oscillator 2016

One of the first products KDS has developed with a »molded oscillator« is the DD3225TS series RTC (Real Time Clock) module.

RTC modules are facing quite a difficult market. Connecting equipment to the internet is common and will further increase in the future. In many cases, a standard clock source using a 32.768kHz wide-tolerance quartz crystal is enough, because the accurate time will be adjusted through communication. Therefore, RTC module usage is kept very limited anyway.

But there are good arguments in favor of using RTC modules. In some cases, for instance, using an RTC module can save energy for the entire system. A 32.768 kHz crystal unit is merely a passive component. So even if the crystal has a low power consumption, the main CPU has to run as

well. To avoid having the main CPU run continuously, the RTC module works independently for the time stamp. This is often used to detect tampering in smart meters.

Moreover, an RTC module offers high accuracy over a wide temperature range. It works as a very stable clock source in any environment, such as high or low temperature regions, or inside electronic devices where it is exposed to heat from other power components.

The KDS Daishinku brand is well known in the automotive market, that's why DD3225T conforms to the AEC-Q100/200 standard.

**Applications:**

High precision clock source, car navigation, smart meter, smart lock, data logger

**What about ceramic packaging products?**

»Molded oscillator« is a new product of KDS, but it is only one series in KDS's wide lineup. Moreover, it does not mean that KDS is going to remove ceramic package products from their lineup.

Actually, the crystal unit itself is needed to be fully hermetic sealed. Hence, the ceramic package solution will not disappear, saturate, or even become a minor technology. After all, ceramic packaging is necessary for crystal-related components.

This also applies to oscillators, which are today used in various environment conditions. Sometimes, they operate under extremely high temperatures. Considering the wide temperature usage, the ceramic package that keeps crystal and IC inside, offers an advantage over the resin-covered »molded oscillator«.

However, a significant volume of the overall demand could be covered by the »molded oscillator«. I certainly hope that this article sufficiently demonstrates the flexibility of the »molded oscillator«. It definitely can be the solution for your requirements.

If you are interested in this topic and wish to obtain more information, please contact:

**P04**

▶ Yasunobu Ikuno, +43 1 86305276  
yasunobu.ikuno@codico.com

Overview of »Molded Oscillators«					
Category	Size	Crystal inside	Frequency	Volume production	Memo
Oscillator	2016	Arkh.3G	~80MHz	Available	Cost effective product
	5032	Arkh.3G	~160MHz	2023/1	
	7050				
PLL Oscillator	2016	Arkh.3G	~160MHz	2023/1	
	5032				
	7050				
RTC Module	3225	DST1610A	32,768kHz	2023/6	Automotive available
32kHz TCXO	3225	DST1610A	32,768kHz	2023/6	
Differential Output SPXO	2520	Arkh.3G	~156,25MHz	2024~	
	3225				



# FILTER-INNOVATION



Over the last few years, vehicles have become increasingly intelligent and autonomous. These challenges require special solutions:

The complexity of connecting ECUs, Infotainment, ADAS, Autonomous Driving Features and other applications throughout the vehicle led to an increased demand for wired high-speed communication. General sensor data as well as video and audio information should be delivered to the corresponding evaluation electronics as quickly as possible. To ensure a safe and reliable

data communication Common Mode Chokes need to filter the conducted noise. Depending on the different communication protocols, there are different requirements to the chokes.

EATON provides a suitable solution for CAN & CAN-FD, FlexRay, USB 2.0 and One-Pair-Ethernet (OPEN) 100BASE-T1. For CAN, FlexRay and USB

2.0 the ACEV1 series has already been introduced and is well established in the market. (see table) OPEN technology is becoming increasingly popular as it requires only one twisted pair cable. This reduces the overall weight of the cabling in vehicles. Based on the IEEE 802.3bw standard, bit rates of up to 100MBits can be realised over a distance of up to 40m.

EATON has optimised the ACE2V3225-201-R to meet the stringent S-parameter requirements of OPEN Alliance 2.0 for 100BASE-T1 communications. The tricky task is to achieve low data conversion and insertion loss while maintaining high common and differential mode noise reduction. These are critical factors that are very difficult to match to all scenarios.

The renowned test laboratory of the Forschungs- und Transferzentrum e.V. an der Westsächsischen Hochschule Zwickau has tested the common mode choke intensively and confirmed compliance with all parameters (see graph).

Samples can be ordered conveniently via the CODICO Sample Shop.

P05

Sebastian Gebhart, +43 1 86305 205  
sebastian.gebhart@codico.com

AUTO COMMUNICATION PROTOCOL			CAN & CAN-FD	FLEXRAY	USB 2.0	ONE-PAIR ETHERNET 100BASE-T1
PRODUCT	FOOTPRINT	SERIES				
Common Mode Filter	0805	ACE1V			ACE1V2012-900-R ACE1V2012-121-R	
	1210	ACE1V ACE2V	ACE1V3225	ACE1V3225		ACE2V3225-201-R
	1812	ACE1V	ACE1V4532	ACE1V4532		

## S-Parameter CMC for 100BASE-T1 Application

Type: ACE2V3225-201-R

Item: S10 - Common to Differential Mode Rejection ( $S_{ds12}$ )

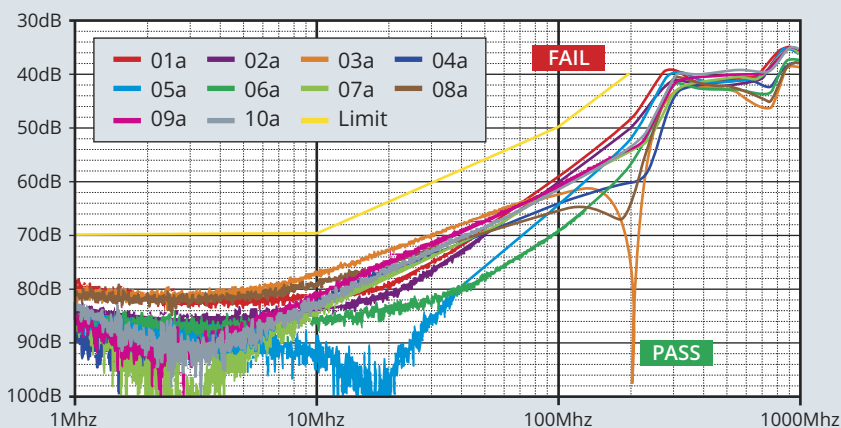

### Future prospects:

The trend to even faster communication continues. EATON already develops a solution for 1000Base-T which will be released soon. The CODICO Newsletter will keep you up to date.



## Possible Applications of Solid State Relays in

# INDUSTRY 4.0

Industry 4.0 is directly linked to the fourth industrial revolution. The first industrial revolution consisted in steam and water power, the second industrial revolution characteristics were by assembly lines and mass production, and the third industrial revolution was represented by electronics, IT systems and automation of the production line.

We have now entered the fourth industrial revolution that uses among other technologies Artificial Intelligence, Internet Of Things, or 3D printing. Industry 4.0 aims to collect as much information as possible in real time, in the most efficient, fast and flexible way and to analyze the collected data. The main advantages of Industry 4.0 are lower production costs and higher quality of the value chain.

### CELDUC® Relais Solid State Relays to Help Implement an »Industry 4.0-Friendly« Production Line

Industrial production has evolved by using new technologies and entering Industry 4.0. Automation and robotics are nowadays the main features of production lines. In order to correspond to Industry 4.0, solid state relays are now offering more and more possibilities in terms of diagnostics, protections, and communication. New solid state relay technologies emerge and allow to collect data in an easy and fast way.



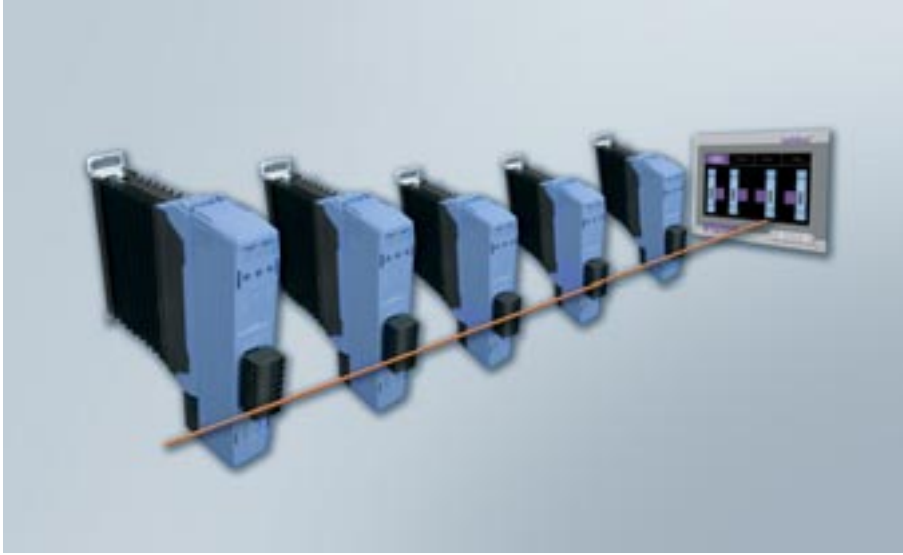

### Solid State Relays Modules with a FIELDBUS communication interface

Fieldbus technology is a group of industrial computer networks aiming to get real time control and feedback from the whole value chain.

Fieldbus Technology allows communication between an input and an output device. For instance, it will allow a solid state relay to detect an anomaly and give the information to a monitoring computer. Workers then are informed in real time of the situation without needing to test the whole production line to get the source of the issue. The advantages of using solid state relays with Fieldbus Technology are a considerable gain of time and costs. Modules have been developed

to be directly plugged on the solid state relay itself, also saving wiring costs.

Solid state relay modules with Fieldbus technology aim to get the status of the load and of the

solid state relay itself, allow current monitoring and a precise temperature control of the heating elements.

In terms of Fieldbus technology, CELDUC® relais has developed the ECOM module. Our ECOM allows a real-time monitoring via a RS485 link and MODBUS RTU protocol. RS485 based connection with protocol MODBUS or CANOPEN (faster) are the cheapest and well adapted solutions to sensors or relays.

The ECOM module has been made to be directly plugged on the celpac® range of 22.5mm wide solid state relays.

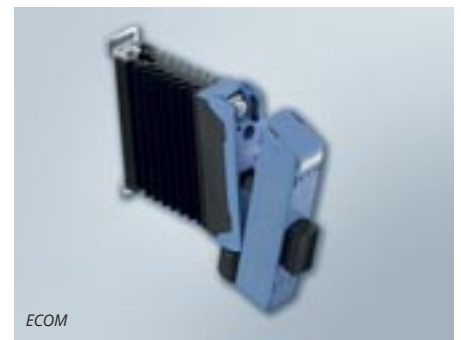

ECOM

### Solid State Relays with integrated diagnostic solutions

Solid State Relays with integrated diagnostic solutions need to be connected to every machine on the production line in order to transfer information about the status.

Solid State Relays with integrated diagnostic solutions can detect various failures on the machine line, such as the status of the load (connected

or not), the relay output (closed or not) and the network (fuse or circuit breaker status) in the power circuit, anomaly on the motor, overheating, and many others thanks to a LED indication.

CELDUC® relais has developed Power solid state relays with integrated diagnostic solutions available in different housings (45 or 22.5mm) such as the SILD, SOD or SOI ranges. As well as AC soft

starters with integrated diagnostic solutions and self-testing such as the SMCV range.



SILD, SOD, SOI



SMCV



©AndresStock/Fractal Pictures





© Adobe Stock / Vadimir

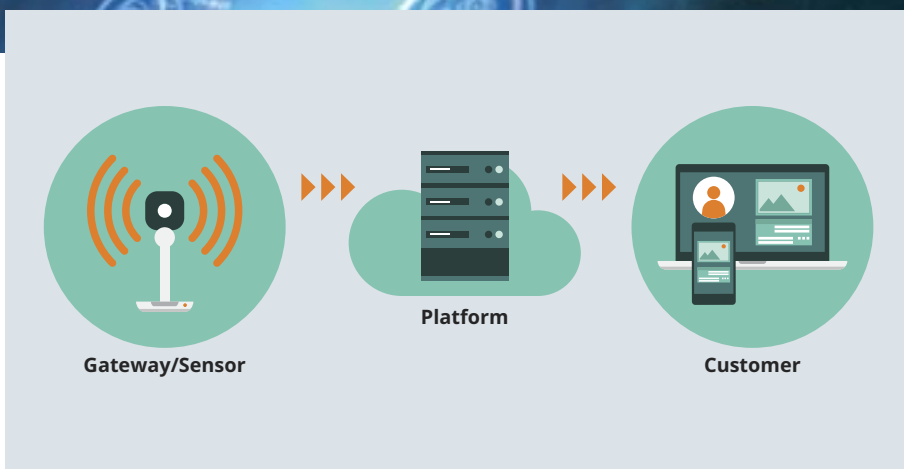

### IoT in Industry 4.0: sensors and connected objects

The Internet of Things (IoT) describes connections between things (physical objects) and technologies such as sensors or software, that allow to exchange data with other devices or systems over the internet or other communication networks.

CELDUC® relais commercializes sensors that are compatible with IoT. With their energy efficient wireless connection modules, CELDUC® sensors can connect all types of detection needs. Thanks to CELDUC® relais professional expertise in the field of magnetic detection, and the combination of reed technology and LPWAN networks (low-power wide-area network), sensors are:

- Autonomous: up to 10 years of uninterrupted use without changing or recharging the batteries
- Simple to use: no SIM card or complex parameters, manage your sensors directly from our web platform and connect anywhere in the world with the same model

- Economical: much more affordable than traditional mobile networks, LPWAN solutions are particularly well suited to connected sensors and now cover more than 90% of world territory.

CELDUC® relais is a specialist in magnetic sensors. Magnetics sensors are based on an electronic or mechanical principle detecting a magnetic field. They can detect without any contact the

presence of a magnet and give an ON-OFF signal to the control system.

The advantages of CELDUC® relais sensors are:

- No power supply needed
- No power consumption when the switch is OFF
- Provides a real galvanic insulation
- No voltage drop at ON state
- Can be used in harsh environments: dust, water, oil, etc.
- Distances for detection can be very large depending on the magnet
- Cost effective

CELDUC® relais proposes a wide offer of position sensors, level & flow sensors, presence sensors, speed sensors and safety sensors.

**P06**

▶ Arnold Geitzenauer, +43 1 86305 124  
arnold.geitzenauer@codico.com

*Authors: Manon Dominici - Global Sales Channels Expert - celduc relais  
Aurélie Reynaud - Marketing & Communication Manager - celduc relais*



Sensors

**AiSHi**  
THINK AHEAD.

# HIGH PERFORMANCE

## THB Film Capacitors

**AISHI launches exceptionally reliable 2,000 hours THB film capacitors suitable for high power industrial and automotive applications requiring high reliability.**

The corrosion-related loss of capacitance is caused by the so-called »temperature humidity bias« (THB). The THB technology is originally known from X2 capacitors, which should keep a

stable capacitance over a longer lifetime. Especially when used in series with the mains, this was very important for a stable, long-term function of power supplies.

Standard X2 capacitors are designed for fast self-healing and safety due to a high proportion of zinc in the metallisation. In particular, higher relative humidity leads to a rapid loss of capacitance, so their use in capacitive power supplies or voltage dividers is not advisable. THB capacitors are specially treated, special materials are used and the manufacturing process is different.

Further tests have shown that DC capacitors are also susceptible to capacitance losses and increased power dissipation. Therefore, this technology has been applied more and more to other types of film capacitors, such as DC link or pulse capacitors, in order to offer highly reliable products for harsh environmental conditions. The increased capacitance stability guarantees long-term reliable operation of various devices, such as solar inverters, UPS or DC charging stations.

**Following 2,000hrs THB-tested products are available:**

- **FDQ series** – Metallized Polypropylene DC-Link Capacitor (450VDC ~ 1200VDC)
- **FAQ series** – Metallized Polypropylene AC-Filtering Capacitor (180VAC ~ 760VAC)
- **FXQ series** – Metallized Polypropylene X2 Capacitor (305VAC/350VAC)
- **FYQ series** – Metallized Polypropylene Y2 Capacitor (300VAC)
- **FXJ series** – Metallized Polypropylene X1 Capacitor (350VAC/480VAC/530VAC)
- **FSQ series** – Double Metallized Polypropylene Pulse Capacitor (630VDC ~ 2000VDC)

AISHI has made further improvements relating to raw materials, design and the production process. As a result, these capacitors pass a 2,000-hour test at 85°C and 85% relative humidity with rated voltage and offer twice the lifetime compared to conventional THB Class IIIB products. In addition, they are AEC-Q200 certified and available in automotive grade.

For more details, samples or a quotation kindly contact:

**P07**

▶ Roland Trimmel, +43 1 86305 144  
roland.trimmel@codico.com

**Humidity Biased Test (85°C 85% RH, Rated Voltage)**

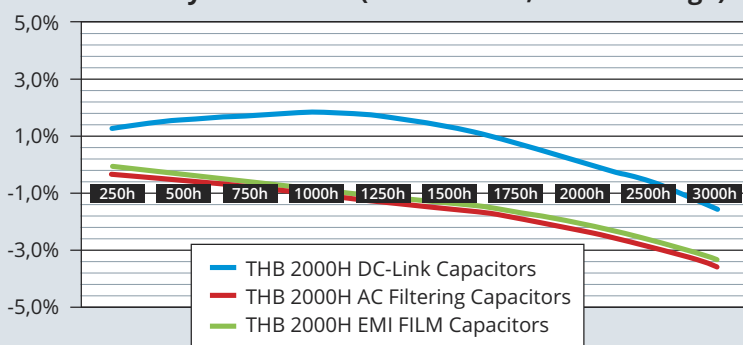

**Humidity Biased Test (85°C 85% RH, Rated Voltage)**

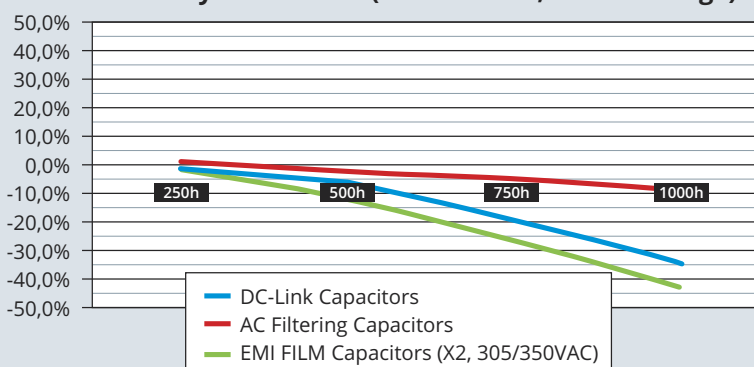

# FOR HARSH ENVIRONMENTS



## Highly Reliable Polymer Capacitor Series



© 2022 Panasonic Industry

PANASONIC INDUSTRY's SP-Cap portfolio of aluminum polymer capacitors is the ideal choice wherever a low ESR would be the primary consideration for identifying the most suitable capacitor.

tor line-up with temperature resistant KX series – 5,500 hours at 125°C, which is the industry's longest\* endurance guarantee. (\*As *conductive*

PANASONIC's advanced solid polymer technology, the SP-Caps, have proven to be an excellent alternative to multilayer ceramic capacitors (MLCCs) and pure tantalum capacitors. They require less parts and space on the PCB and provide much better performance, especially for modern and complex low-profile electronic devices, with large capacitance up to 820µF and a ripple current up to 10.2Arms.

With the evolution of telecommunication equipment, high reliability capacitors with long lifetime and resistance to high humidity in addition to large capacitance are required in power supply designing. PANASONIC INDUSTRY enters a new era by extending SP-Cap aluminum polymer capaci-

### Comparison with Conventional Products

	Conventional Product HX Series	JX Series	KX Series
Durability Guarantee	125°C 1000h	125°C 3000h	125°C 5500h
High Temperature & Humidity Guarantee	60°C 90% 500h	85°C 85% 1000h	





Contributes to a high reliability in output side applications of power supply circuits in, for example, communication base stations and servers.

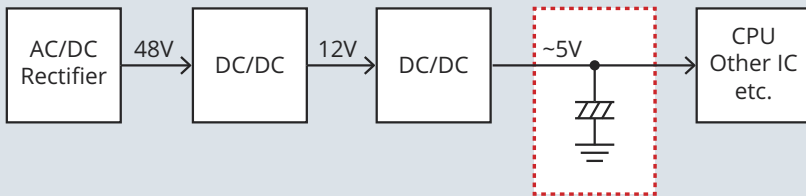

The closer it is to the CPU, the more susceptible it is to the heat from the CPU. **JX series/KX series** with high temperature guarantee is optimal.

*polymer aluminum electrolytic capacitors as of February 28, 2022 [Panasonic data]*

Combining PANASONIC's proprietary conductive polymer formation technologies and manufacturing processes, the new products have more than three times the life of conventional products and additionally a high temperature and humidity guarantee.

JX-/KX-series key points for enhancement in terms of long lifetime at high temperature and high temperature and humidity endurance (85°C/85%/1000h guarantee):

- The key material used is an improved conductive polymer that suppresses deterioration compared to conventional products.
- Oxygen intrusion, which causes deterioration of the conductive polymer, is delayed by changing the exterior resin.

Coming with the typically low ESR of 9mΩ, a large capacitance, a low profile, long life span and high characteristic stability, this latest member of the SP-Cap family stands out with an endurance of 5,500 hours at 125°C and thus promises an outstanding reliability. The remarkable damp heat specifications – 1,000 hours at 85°C, 85%RH –

similar to JX series, render it suitable for demanding outdoor applications.

Shahrokh Kananizadeh, Product Manager at PANASONIC INDUSTRY, is well aware that there are a lot of them: »The KX series has many benefits in a wide range of applications, such as noise reduction or voltage smoothing in base stations, networks, servers, accelerator cards and industrial equipment. Briefly said, the KX series sets new standards in terms of high temperature reliability – and underlines the superiority of polymer technology for new designs.«

**SPECIFICATIONS**

**JX series**

Voltage range: 2V to 6.3V

Capacitance range: 120µF to 470µF

ESR (100kHz/+20°C): 3mΩ to 15mΩ

Temperature range: -55°C to 125°C

Endurance: 3,000h at 125°C

**KX series**

Voltage range: 2V to 2.5V

Capacitance range: 220µF to 470µF

ESR (100kHz/+20°C): 9mΩ

Temperature range: -55°C to 125°C

Endurance: 5,500h at 125°C

**P08**

► Roland Trimmel, +43 1 86305 144  
roland.trimmel@codico.com

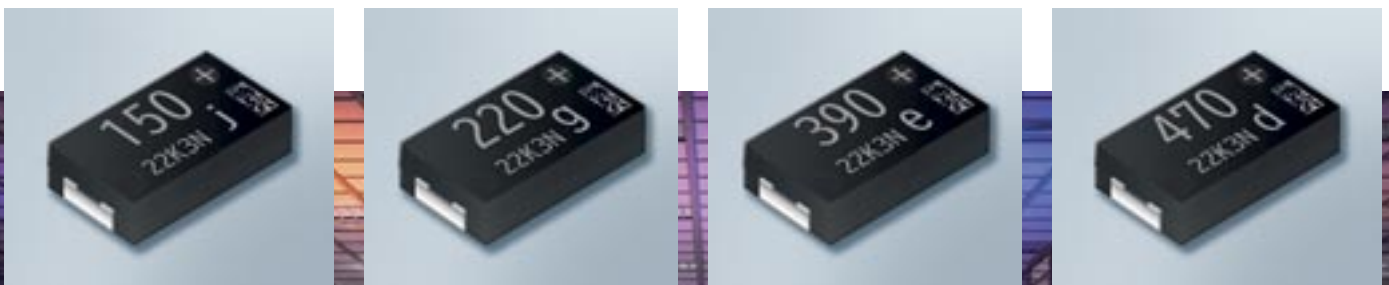



# EFFECTIVE

## Absorbing Voltage Peaks: Protection for Driver Outputs



During quick switching processes in power electronics such as those found in high-efficiency DC/DC converters in DC fast chargers, voltage peaks may cause inductances that can damage or destroy sensitive downstream components in the electrical circuit.

A so-called RC snubber shunt, which dissipates the excess energy outwards, can dampen such voltage peaks. Illustration 1 shows the general structure, where SW stands for the switch in form of an IGBT, Si, SiC or GAN MOSFET. R is the ISABELLENHÜTTE resistor, and C could be a polymer capacitor (PML-Cap) from RUBYCON, or a film or power ceramic capacitor from KEMET.

ISABELLENHÜTTE has created a powerful low-ohmic snubber shunt, SMT-V, with an exceptionally high pulse power rating. An RC member consists of a resistor (R) and a capacitor (C) connected in series. The resistor is used to convert the energy discharged from the capacitor into heat. Snubbers are used in combination with contactors,

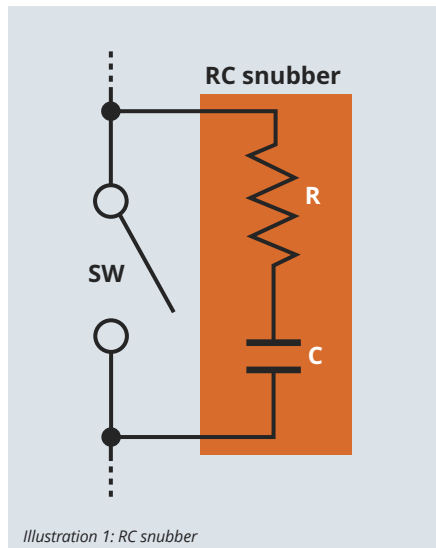

Illustration 1: RC snubber

power relays, thyristors/Triacs, IGBTs, MOSFETs or bipolar transistors. Especially IGBTs, Triacs and MOSFETs are used to precisely control motors. Ensuring this requires rapid switching operations of the IGBTs and MOSFETs.

Illustration 2 shows a characteristic image of overshoot and ringing. Both phenomena can be mitigated through a proper design of the RC member.

### Low-ohmic snubber shunt for high pulse loads

At 17.5mΩ, the SMT-V developed by ISABELLENHÜTTE has a low resistance value and a very compact design. It is based on the existing SMT current sense resistor, whose large copper legs allow for excellent heat dissipation from the respective component, and which already offers a high pulse load capacity and long-term stability. However, the design and material of this new SMT-V were



Optimised film design using Noventin®

This high pulse power rating is achieved thanks to an in-house resistance material, Noventin®, which has a specific resistance almost twice as high as Manganin®, which is employed in existing current sense resistors. The component's basic structure was maintained, only the film design was optimised and the resistance material was adjusted accordingly. This allows for much higher pulse loads and power losses at the resistor. The SMT-V is able to absorb a pulse energy of 2.5 J at a pulse duration of 0.1s at a terminal pad temperature of 120°C and 50 pulses over the lifecycle with a corresponding gap time (Illustration 2). This corresponds to a power loss of 25W per pulse.

Application example of protective circuitry in power conversion

For instance, snubber shunts can be used as part of a protective circuit for semiconductors in the AC/DC converter of a DC fast charger.

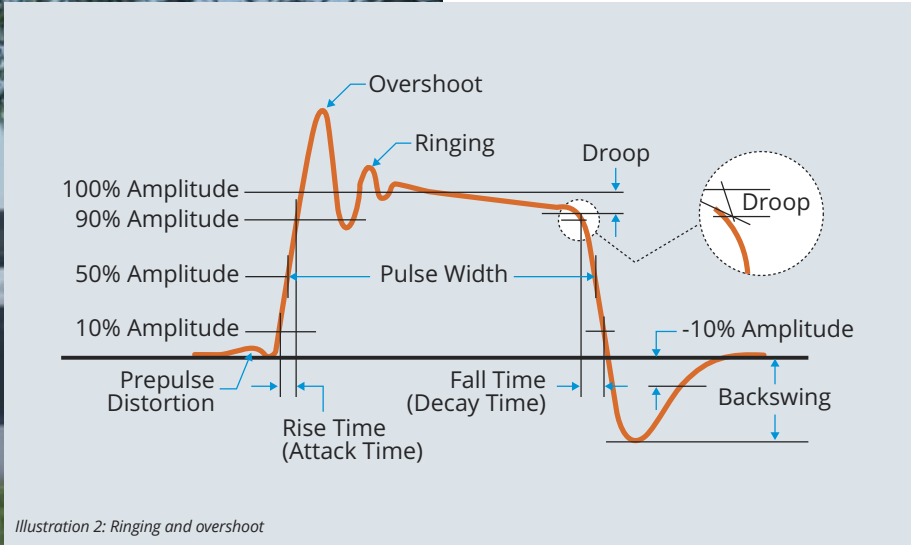

Illustration 2: Ringing and overshoot

standard component on the market offering such resistance. The unique feature of this snubber shunt compared to other shunt series from ISABELLENHÜTTE is that it is not used for current measurement, but to specifically absorb high pulse loads.

adapted to better withstand this particular pulse load. The development was the result of a customer request, since there was no adequate stan-

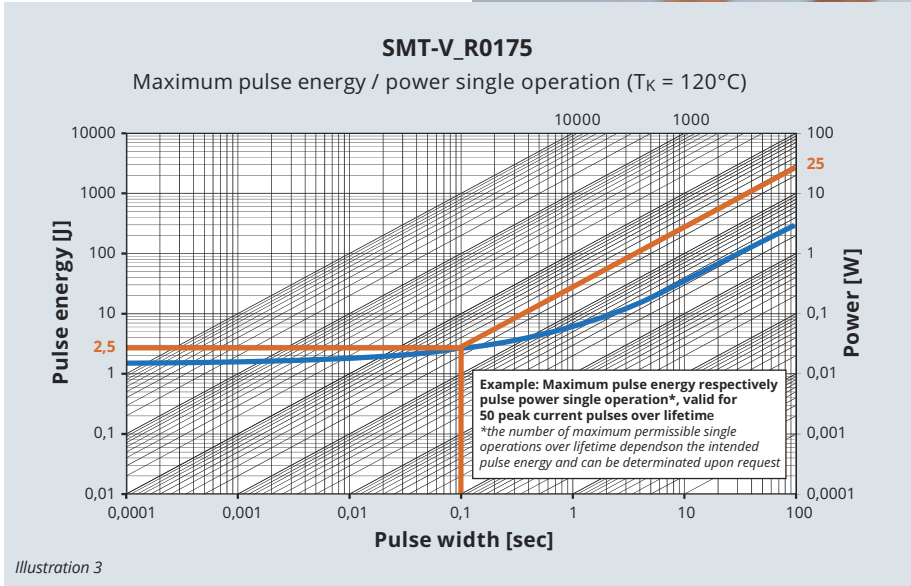
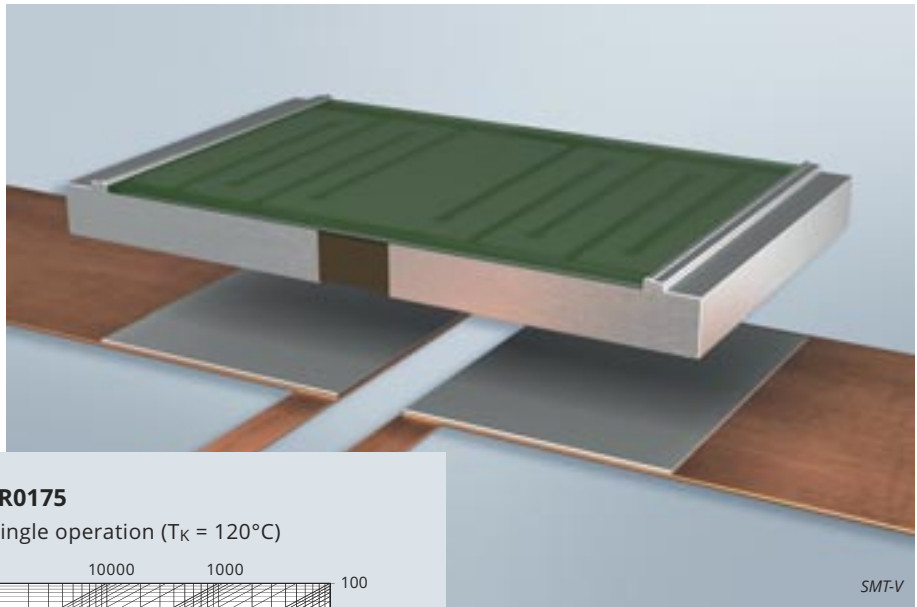

Illustration 3

C samples can already be provided, and serial production of the SMT-V will begin this quarter. Other resistance values and sizes (such as 2512) can be considered upon customer request. For further questions, do not hesitate to contact us. We will be happy to support you in implementing your new power conversion product.

P09

➤ Rainer Scalick, +43 1 86305 366  
rainer.scalick@codico.com



# PROJECT WALLBOX



© ddbb/Stock/Pool-Thomann

representative. To implement the current measurement, we make the following assumptions:

- The wallbox will be installed outdoors and the ambient temperature results in a maximum PCB temperature of 65°C.
- Maximum current 32A
- Input voltage 230VAC
- 24-bit analog-digital converter
- Maximum input voltage ADC  $\pm 450\text{mV}$  absolute max. rating
- Measurement signal at 32A to 18mV

Our aim is to find a suitable shunt with the correct power and the maximum admissible pulse power.

Considering the voltage drop and the current, the R value should be between 500-600 $\mu\Omega$ . At 300 $\mu\Omega$ , the measurement signal will drop to 9.6mV. The BVB by ISABELLENHÜTTE could easily cover this value range. The BVB is an ISA-WELD<sup>®</sup> component with a power rating of up to 12W, and even features a connection for 4-terminal method measurement. The ohmic value ranges between 0.2 and 5m $\Omega$ . In this case, let's look at the maximum permissible pulse. At 0.45V and 300  $\mu\Omega$ , this would be a pulse load of approximately 1,500A and thus 650W. Figure 1 shows the pulse load diagram of the BVB series. It is easy to see that the series can withstand a pulse load of 6-700W for 10ms without any problems. For the 300 $\mu\Omega$  shunt, the limit is 500W.

## Conclusion

In this article, we have given an overview of how a high-precision shunt measurement can be carried out inside a wallbox and how the necessary parameters can be determined using the pulse diagram in the data sheet. If you need more information, please contact us and let us talk about your wallbox project.

**P10**

► Rainer Scalick, +43 1 86305 366  
rainer.scalick@codico.com



## Current Measurement Design for a 230VAC/ 32A Charger

Due to the switch from fossil primary energy sources to renewable energy sources, there is an increasing demand for charging devices for electric vehicles. In this article I would like to deal specifically with the topic of current measurement.

Let's start with the structure inside the house from the mains to be connected, or in other words in the fuse box at the residual current circuit breaker. As a rule, there is a standard residual current circuit breaker in the existing system, which switches off at 30mA in the event of an AC fault to ensure personal protection. This is follo-

wed by the circuit breaker, which, as the name suggests, protects the line from thermal damage (due to excessive current flow). After the circuit breaker, the wallbox is connected directly to a terminal block by means of cable wiring. For a more detailed description of the wallbox, please read Impulse 02/2021, or contact our sales re-

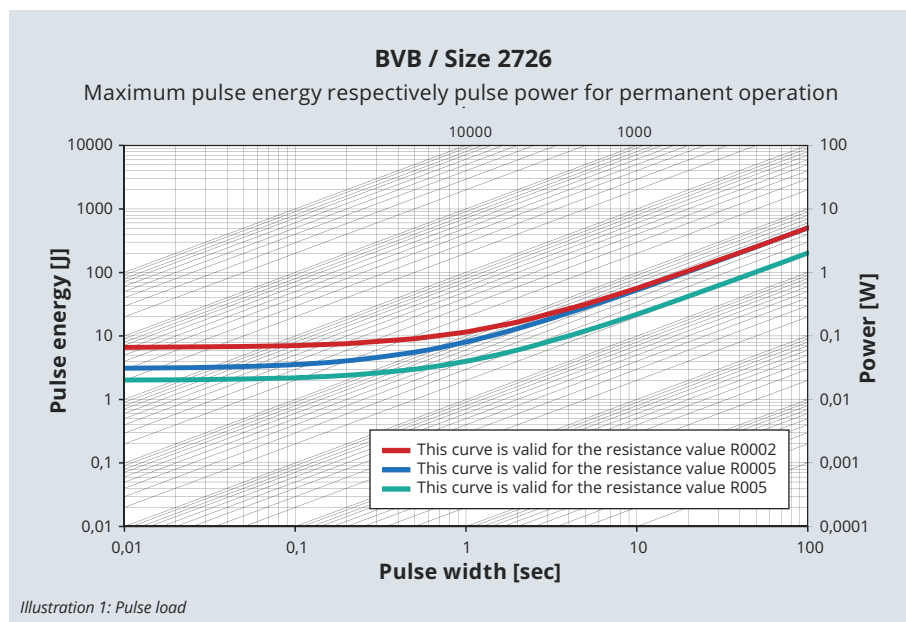

# GREEN RELAY

## High Performance PCB Power Relay for EVSE Applications

Electro mobility and other alternative technologies continue to grow very fast globally. A few years ago, our partner SONG CHUAN shifted their strategic focus to developing relays for green energy applications.

**S**ONG CHUAN offers the new 207BX, a powerful low profile one pole relay with NO contact, a contact gap of  $\geq 1.5\text{mm}$  and reinforced insulation. Low profile means only  $16 \times 21.5\text{mm}$  space requirement on the PCB. The 207BX relay is able to carry 35A at 277VAC. High short circuit capability  $I_p = 1.85\text{kA}/I^2t = 4.5\text{kA}^2\text{s}$  at  $I_{in} \leq 32\text{A}$  and 500A (three operations) switching capability acc. IEC62955 makes the 207BX perfect for use in charger applications. High Inrush capability of 230A in accordance with IEC 62752 makes it

interesting not only for electric vehicle charging equipment, but also for a wide range of other industrial applications where high switching capacity is required. The holding voltage of the coil can be reduced to 32–34% of the rated voltage of the coil to save energy. The relay is UL/CUL and VDE approved. The new 207BX is RoHS compliant and is ideally suited for use in harsh environmental conditions due to its high temperature resistance up to max. 85°C ambient temperature.



207BX

### Typical applications

- Electric Vehicle Charger applications e.g. Wallbox, Cordset
- Photovoltaic power generation systems (solar inverters)

P11

► Wolfgang Weiß, +43 1 86305 334  
[wolfgang.weiss@codico.com](mailto:wolfgang.weiss@codico.com)

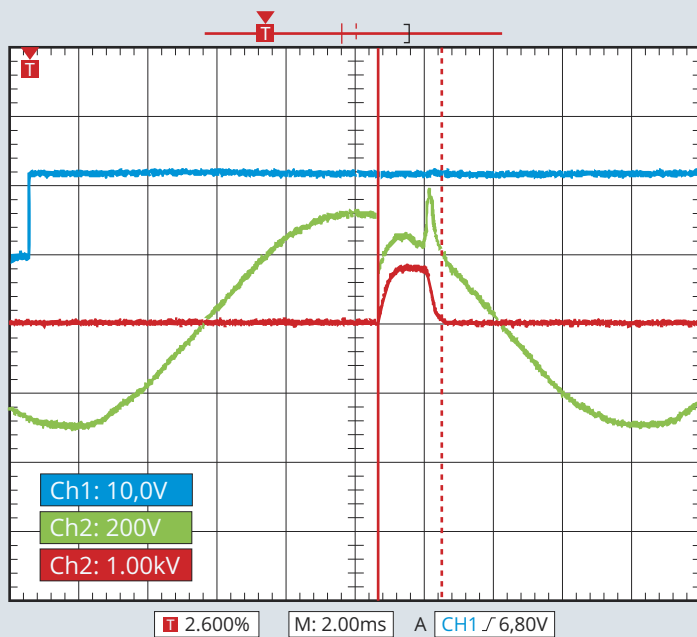

$$920\text{A} \times 2 = 1.84\text{kA} (1.84\text{ms})$$

$I_p = 1.85\text{kA}$  and  $I^2t = 4.5\text{kA}^2\text{s}$  at  $I_{in} \leq 32\text{A}$  according to IEC 62955  
 For short circuit test, the test is with fuse & the phase angle is within  $\pm 15$

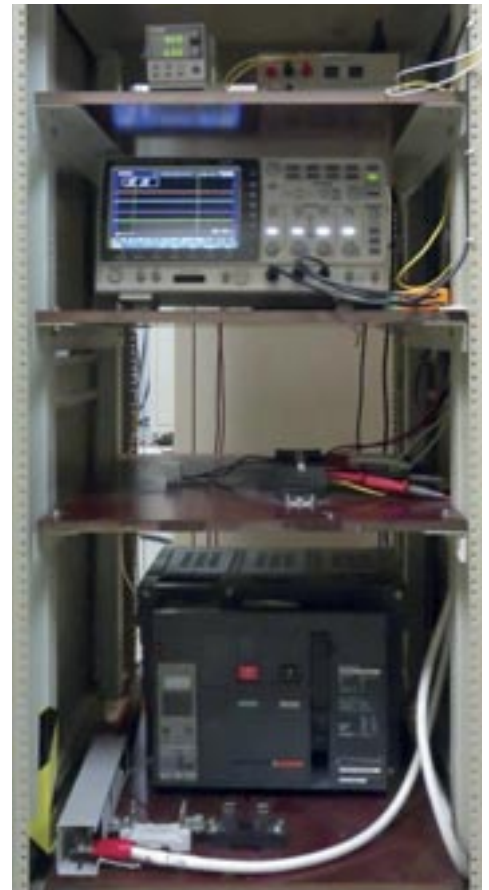

Equipment

# LET'S CHARGE



## Automotive Interconnect Solutions for EV Charging

Amphenol

AMPHENOL offers a broad array of innovative automotive-grade interconnect solutions from wire-to-board, board-to-board, input-output, power management, to FFC-FPC connectors.

For EV Charging there is a wide portfolio of power products supporting 15A-1000A ratings, low contact resistance, high thermal support and component modularity. AMPHENOL offers the most efficient solutions for the modern EV charging station. The energy efficient connectivity extends from level 2 chargers to level 3 Super-Fast chargers capable of charging an EV battery in less than 30 minutes, in addition to IP67 sealed connectivity for underground wireless charging.

Level 2 EV chargers are capable of charging a 40kWh battery in 3-7 hours and a 75kWh battery in 5-11 hours. AMPHENOL supplies energy-efficient high-performance connectors that are installed in the power module boards of these charging stations.

Level 3 EV chargers are high performing super speed chargers capable of charging 40kWh battery in just 30 minutes and 75kWh in less than two hours. AMPHENOL offers enhanced power

connectors for power modules and bus bars that meet current and voltage ratings of 100A and 480V.

The quick charging Super-Fast Chargers save time by giving the EV the quickest boost. AMPHENOL's busbar connector and cable solutions are ultrasonically welded and offer a current carrying capacity of up to 200A/contact to the heavy-duty AC/DC power inverters.

Wireless EV charging systems located underground can charge the EV parked above using induction technology. AMPHENOL promises sealed high power solutions with IP67 specifications that are custom designed for the charger cabinets of ten prone to harshest of weather conditions.



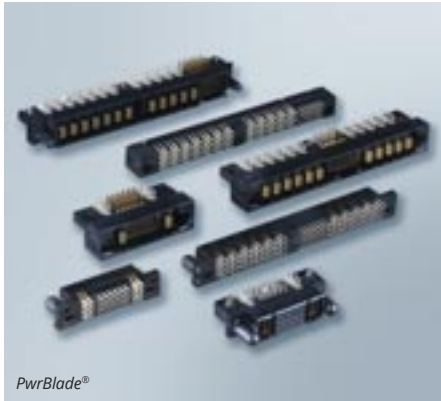

PwrBlade®



PwrBlok®



SheerPwr™

## FEATURED PRODUCTS

### PwrBlade®

The PwrBlade® family contains series PwrBlade®, PwrBlade+® and PwrBlade ULTRA®. All of them combine power contacts for power distribution and signal contacts for power control. Number and placement of power and signal contacts are highly configurable for custom power needs. Besides right angle and coplanar options and also low profile, blind mating versions and cable connectors are available, too.

The main difference between PwrBlade®, PwrBlade+® and PwrBlade ULTRA® series is their current carrying capacity:

- **PwrBlade®**: 48A/individual power contact; 30A/contact for 10 adjacent contacts at 30°C temperature rise in still air
- **PwrBlade+®**: High power contact option up to 58A/contact, at 30°C temperature rise in still air
- **PwrBlade ULTRA®**: Up to 75A/contact for high power and up to 45A/contact for low power

### PwrBlok®

PwrBlok® provides a high current connection with quick connect/disconnect function for space

constrained board-to-board, board-to-busbar, and busbar-to-busbar power distribution applications.

- Current carrying capacity from 65A to 140A
- Press-fit tails for mounting on PCBs and busbars

### Barklip® I/O

The Barklip® I/O provides a convenient method of distributing up to 200A between busbars, cables and PCBs. It features 14 fully independent cantilevered bars, providing a true compliant spring to adjust for variations in bus bar alignment and surface finish. The ultrasonically welded connection between the wire and contact increases efficiency and reliability for current transition. The cable is connected to the system rack bar, a 3.0mm thick copper bar, to achieve a direct pluggable connection to an uninsulated busbar.

### SheerPwr™

SheerPwr™ Circular is a high-current, low-impedance interface designed for connecting busbars to PCBs. It uses a robust and compliant power contact mounted in a circular orientation. The result is a power socket, designed to mate with tra-

ditional machined pins, which provides repeated low resistance, high misalignment and high current carrying capacity.



Minitek® 4.2

### Minitek® Pwr

The Minitek® Pwr family is an optimised product sold as a complete solution including wire-to-wire and wire-to-board, in pitch sizes of 3.00mm, 4.20mm and 5.70mm, with current ratings from 6.5A to 23A. In short, Minitek® Pwr is compact, robust and versatile, which suits different customer application needs even with blind mating.

S01

Julia Reiterer, +43 1 86305 162  
julia.reiterer@codico.com



PwrBlade+®

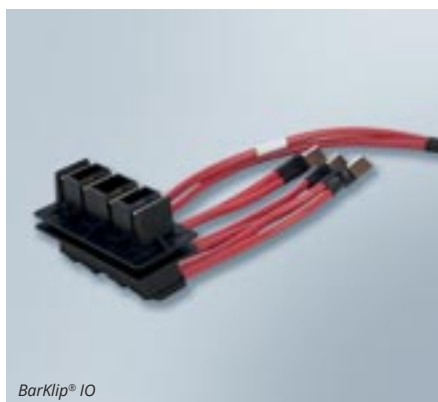

Barklip® I/O

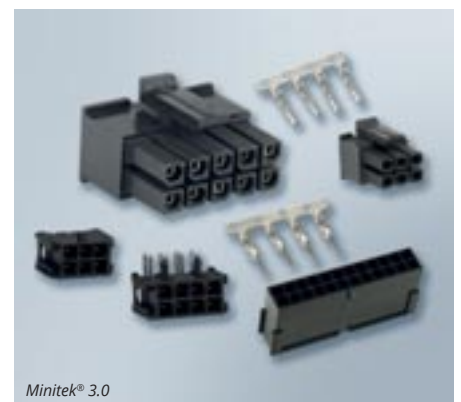

Minitek® 3.0



# FlexLock®

## PwrBlade® MiniMezz Connector Series

Amphenol

Lowest profile hybrid mezzanine connectors.

The PwrBlade® Mini connector series introduces enhanced features to AMPHENOL's existing PwrBlade® products in a smaller profile. PwrBlade® MiniMezz is available in stack heights ranging from 8-20mm with options for power & signal contacts. It also has blind-mate guides that allow for ±0.80mm of gather ability for blind-mate applications. PwrBlade® MiniMezz will have press-fit tail or solder tail terminations available. PwrBlade® Mini will also have options for board-to-board and cable-to-board configurations coming soon.

### Features

- The lowest profile power & signal mezzanine connectors available
- Modular tooling to accommodate wide range of application requirements
- 8-20mm stack height combinations, tooled in 1mm increments
- Solder-tail or press-fit terminations
- High blind-mate gather ability of ±0.8mm

Target Markets & Application: Communication, Data, Consumers, Industrial & Instrumentation.

S02

Julia Reiterer, +43 1 86305 162  
julia.reiterer@codico.com



PwrBlade® MiniMezz

AMPHENOL's FlexLock® FPC-to-Board connector's compact design addresses the growing demand for the automotive application market.

It can be used in Battery Management System (BMS) and connects flexible printed circuits to the BMS, which monitors and manages the output, (dis)charging and provides notifications on the status of the battery pack. As BMS consists of several electronic systems, interconnect technology is important to ensure control of all diagnostic and safety functions.

FlexLock® is an alternative to discrete Wire-to-Board solutions and eliminates the need for complex, bulky wiring harnesses and enables simple layouts to reduce weight.

It is a modular system based on 2.54mm and 3mm pitch equipped with Connector Positioning Assurance (CPA).

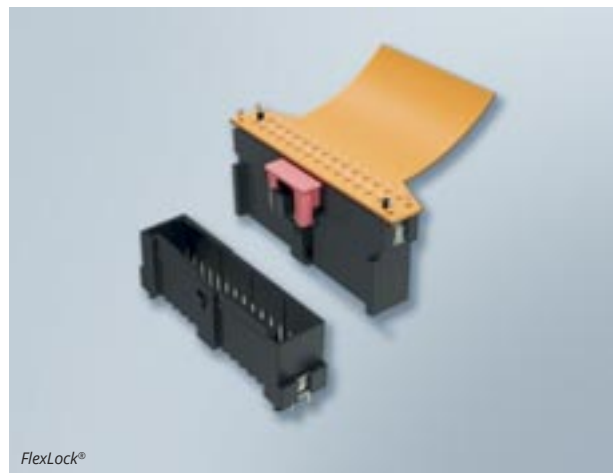

FlexLock®



Amphenol

## FPC-to-Board Connectors

FlexLock® 2.54mm pitch is available in 10 to 30 positions double row with vertical and horizontal TH configurations. FlexLock® 3.20mm pitch is available in 10 to 26 positions double row with horizontal TH configuration.

The connector design is compliant to USCAR-T2V2 specifications and can be used in BMS, EV Power Converter Control as well as in Energy Storage Systems and Robotic applications.

### Advantages for the application

- Allows direct connection between the structure of automotive FPC and the board
- Eliminates the need for complex, heavy wire assembly
- Allows for easier assembly and is more cost effective compared to discrete wire connections

S03

Julia Reiterer, +43 1 86305 162  
julia.reiterer@codico.com



FlexLock®

CviLux Corporation

## CP35: According IEC 60335-1

The popular CP35 connector system from CVILUX in 3mm pitch can now be offered as a GWT version according to IEC 60335-1. The plastic Nylon10T is used for the GWT versions.

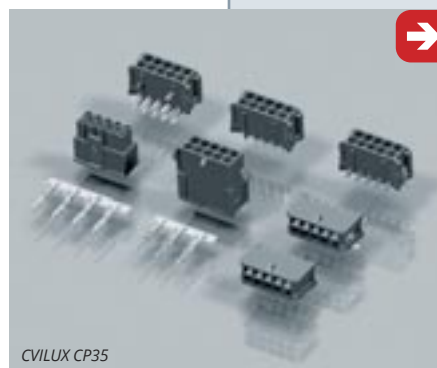

CVILUX CP35

The CP35 series is a wire-to-board system available in single and double row. In the single-row version, numbers of poles from 2 to 12 are possible and the double-row version is available with 2-24 poles. The PCB headers are available straight or angled in SMT or THT with optional retention pins to ensure a strong mechanical connection. Polarisation prevents mismatching and the integrated locking mechanism in the housings ensures high retention force. The contacts are designed for conductor cross-sections of AWG20-AWG30.

The power connector is suitable for applications with a maximum current of 7A at 600VAC and using AWG20 wire. It can withstand a dielectric voltage of 2200VAC for the period of one minute.

This system is often used in home appliances, power supplies, but also in the industrial market.

S04

Julia Reiterer, +43 1 86305 162  
julia.reiterer@codico.com



# DINKLE NEWS

## Series 0183

Pioneering Terminal Blocks

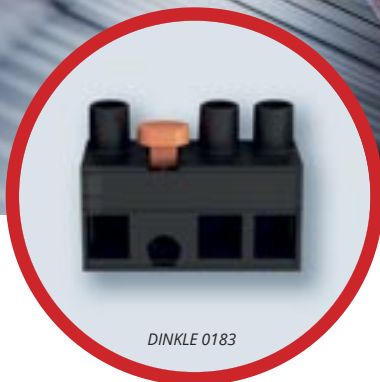

The 0183 Series from DINKLE is a screw terminal block with reliable and efficient performance for power devices such as servo and frequency converters. It has been widely used in industrial automation, digital control devices, industrial robots and other devices that require a safe power connection.

The 0183 series stands out with three special features that create a clear and user-friendly environment for your industrial application.

### Obvious Sectionalisation

The eye-catching orange flange divides the connection area into two parts and helps the wires from AWG #20 to AWG #10 connect in the right place. The position of the flange with the First-make-contact for grounding can be selected as required.

### Space Optimisation

The unique orange flange with M3 screws reduces the space required on the sides, which meets the design requirements of servo drives towards miniaturisation. The pluggable terminal blocks are available in pitch size 7.62mm for a maximum of 12 contacts in one row.

### Stability and Safety

The 0183 series has been rigorously tested to UL 1059 and IEC standards ensuring a reliable operation at 630V and 32A (IEC). DINKLE has also conducted further tests for torque and rotational stress to achieve the highest reliability of the mechanical performance.

DINKLE continues to develop and innovate the most suitable terminal blocks to meet market demands and help you to achieve the highest product quality and improve the competitiveness of your final products.

S05

Christian Sichtar, +43 1 86305 134  
christian.sichtar@codico.com

## Series 0229

Press-to-Release for Actual Tool-Free Operation

The 0229 series from DINKLE features a new wiring design with innovative pushers to enable completely tool-free connection and disconnection of the wires. By eliminating the need for screwdrivers, you and your end customers can save even more time and space.

With commercially available Push-In terminal blocks, a screwdriver or similar tool is usually required to release the wires. When using the new 0229 series from DINKLE this process takes place completely without tools thanks to innovative Press-to-Release pushers. All contact chambers can even be actuated simultaneously with a separately available ejection aid. Just imagine how much time you can save and how flexible the wiring can be.

The PID clamp design allows direct connection of solid or stranded wires from AWG #28 to AWG #14 without tools. Besides the fast and secure wiring, the 0229 series also offers numerous

#### FEATURE 1

#### Obvious Sectionalization

The prominent orange flange divides the connection area into two parts and assists the wires in connecting to the proper position. The flange position can be freely customized as requested.



#### FEATURE 2

#### Space Maximization

The unique orange flange reduces required rooms at the sides, which meets the design requirements of the servo drive towards miniaturization.

#### FEATURE 3

#### Stability & Safety

The 0183 series tested strictly according to UL1059 standards. DINKLE has also conducted more tests for torque and rotational tension to achieve higher reliability of mechanical performance.



locking options for vibration-proof connections. In addition to the widely used screw flange you can also choose from locking tabs and locking levers. The double-row design of the 0229 series offers a space-saving connection in pitch size 5.08mm for a maximum of 40 contacts and gives you the opportunity to optimise the design of your device.

The widening of the contact area by using flat contacts enables an increase in the maximum output current and makes the operating performance of your devices more stable compared to traditional round pins. They are ensuring a reliable operation at 300V and 12A (UL). The connectors are UL 1059 and IEC 61984 compliant.

When using conventional lever terminals, a height of about 8.6mm has to be reserved for the actuation in the switch cabinet. With the 0229 series Press-to-Release design, only 3mm is required, which means a space saving of about 65% in the control cabinet.

The new 0229 series from DINKLE supports the Industry 4.0 trend by providing a flexible solution and firm wire connections in a variety of applications e.g. automobile, communication and data processing fields.

S06

▼ Christian Sichtar, +43 1 86305 134  
christian.sichtar@codico.com



## Series 0274

### A new Tool-Free Solution with many Advantages

There is no longer any room for screwdrivers in modern PCB terminal wiring. The 0274 series is a tool-less terminal block specifically designed for charging applications. The new design with the operating lever brings a comprehensive upgrade to the use of PCB terminal blocks and offers three main advantages:

#### Tool-less operation

The levers can be efficiently operated by hand to safely connect solid conductors and wires with ferrules from 0.75mm<sup>2</sup> to 16mm<sup>2</sup>. Fine stranded wires can be clamped and also released in the same way without tools. The conductor connec-

tion can be made either parallel or at right angle to the PCB.

#### Space-saving design

Due to the toolless operation of the levers, wiring can be carried out easily and safely even in the most confined spaces in a switch cabinet. The terminals are available in 5, 7.5 and 10mm pitches, each with 2 to 12 contact chambers.

#### Flexible handling

The ergonomic design of the lever with user-friendly curvature allows you to make corrections and improvements to the wiring anytime and anywhere.

In addition, the 0274 series offers visible test points for voltage detection and improvement of electrical stability. The modular housing allows individual colour coding for each contact chamber for better identification. Together with optional labelling, human error is more easily avoided, improving operational efficiency.

The terminal blocks comply with UL and IEC standards. With a 10mm pitch, they ensure reliable operation at 600V/51A (UL) and 1000V/76A (IEC). The 0274 series provides excellent support for vehicle electrification in EVSE (Electric Vehicle Supply Equipment) applications.

S07

▼ Christian Sichtar, +43 1 86305 134  
christian.sichtar@codico.com



# GOOD VIBES



## Floating Board-to-Board Connector for Applications with Vibrations



© Hirose Electric (Europe) Ltd.

HIROSE's FX26 is a high contact, reliable and durable Board-to-Board floating connector with an operating temperature of -40 to 140°C.

The series provides a space-saving, float-mount connector that offers tolerance compensation of  $\pm 0.7\text{mm}$  in the X and Y directions, with 1mm pitch and low profile. The tolerance in the Z direction is  $\pm 0.75\text{mm}$ . Its unique floating

structure solves the problem of contact failure due to vibration. The FX26 connectors are small, easy to assemble and offer excellent performance in vibration environments and numerous options for combining different mating heights.

The FX26 series connectors are the ideal solution for vehicle powertrain devices such as PCU, inverter, converter, EPS, motor, battery control, motion control, airbag, ADAS devices and information devices such as Navi, HUD, IVI, audio display and many more.

**FunctionMAX™**



HIROSE's FX26

FX26 series is available with 20, 30, 40, 50, 60 contact positions, and a variety of mating heights are available with 15, 18, 20, 23 and 25mm. Additional variants are under development.

HIROSE's FX26 series is part of the FunctionMAX™ product family. FunctionMAX™ consists of board-to-board connectors designed for maximum functionality. Thanks to the unique contact design and the selection of materials with excellent thermal properties, the FX26 is suitable for environments up to 140°C. It also features a two-point contact design that increases contact reliability.

### Features

- Contact pitch [mm]: 1.0
- Stacking height [mm]: 15, 18, 20, 23, 25
- PCB orientation: Parallel
- Rated Current [A]: 0.5
- Rated Voltage [V]: AC/DC 125
- Operating temperature range [°C]: -40 to +140
- Number of contacts: 20, 30, 40, 50, 60
- Mating cycles: 10
- Contact plating specification: Gold

S08

Julia Reiterer, +43 1 86305 162  
julia.reiterer@codico.com



# GT50 SERIES

## Robust Wire-to-Board Connector with 125°C Operating Temperature



HIROSE's GT50- series combines its compact size with a 1mm pitch and 5.97mm height to reduce the mounting area in PCB designs. The connectors have a gold plating and can withstand operating temperatures of up to 125°C. With this heat resistance, the connector meets the requirements for automotive applications.

Despite its compact design, the GT50 series has a terminal lance that prevents the contact from coming out of its housing chamber. This allows a holding force of at least 12N solely through the »primary latch«. The connector does not have a secondary interlock. In addition, the GT50 has sufficient latch strength and PCB pull-off strength, making it a robust connector for internal connections.

The 2-point contact is sandwiched between two springs to ensure a reliable connection by contacting both sides of the contact where the direction of heat shrinkage is most likely to occur. This improves contact reliability by minimising the effects of heat shrinkage. The applicable wire size is 0.08mm<sup>2</sup> (AWG 28), which is approximately 75% lighter than the 0.3mm<sup>2</sup> (AWG 22) wire diameter commonly used for internal connections in automotive applications.

GT50 series connectors are ideal solutions for automotive applications such as LiDAR, head-up display (HUD), combination light, display, microphone/speaker array or electric mirrors. In addition,

it can be used for automated driverless robots (AGV), autonomous mobile robots (AMR) and power tools exposed to harsh environments.

### Features

- Contact pitch [mm]: 1.0
- Height [mm] / Depth [mm]: 5.97/10.5

- Rated Current [A] :  
2 (2, 4 contacts)  
1.5 (6, 8, 12, 16 contacts)
- Rated Voltage [V]: AC/DC 60
- Operating temperature range [°C] : -40 to +125
- Number of contacts: 2, 16  
(4, 6, 8, 12 under planning)
- Mating cycles: 10
- Termination AWG: 28
- Contact plating specification: Gold

S09

Julia Reiterer, +43 1 86305 162  
julia.reiterer@codico.com

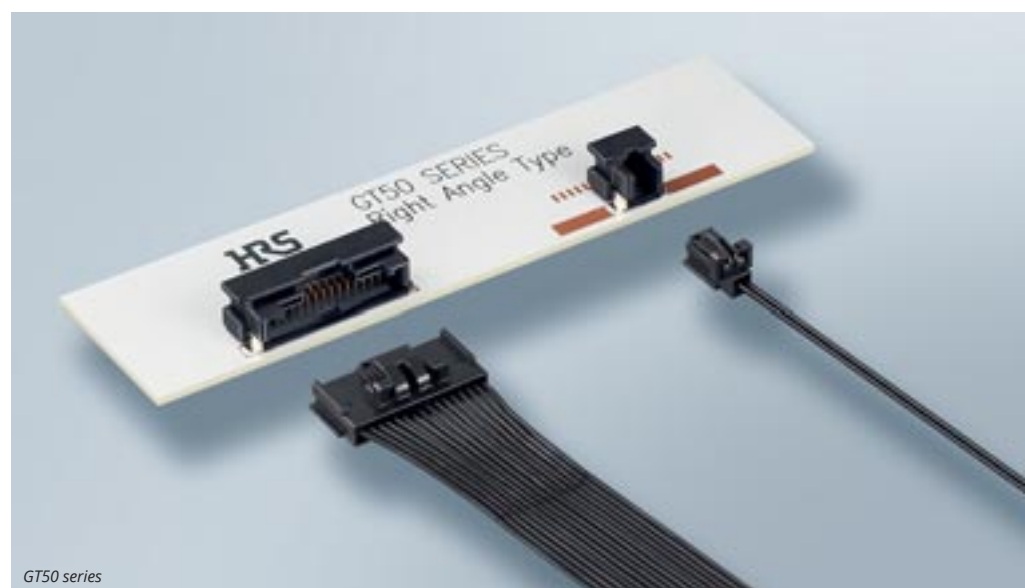

GT50 series



# SAVE: ZH05

## Wire-to-Board Connector for Electric Shock Prevention



### HIROSE's ZH05: Ideal for Battery Electric Vehicles (BEV) and Hybrid Electric Vehicles (HEV/PHEV).

The newly developed ZH05 has been designed to meet the current requirements for internal battery connections in EVs and hybrid cars. ZH05 is available in different pin variants to meet the wide range of battery connection requirements. The reliable design meets automotive quality requirements and can also be used for industrial storage batteries exposed to harsh environments.

The ZH05 series meets automotive quality standards, including 125°C heat resistance and high vibration. It is also designed to prevent short circuits due to dust buildup and electric shocks to employees. This automotive connector can be

used for a variety of electronic components such as batteries, chargers and various ECUs.

### Innovative design ensures high safety

HIROSE has developed an innovative design to prevent electric shock. A box-shaped female contact surrounded by resin is used for the connector on the PCB side to prevent short circuits and electric shocks. Even if dust gets into the contact, a short circuit will not occur.

In addition, this design prevents workers from touching the contacts. The use of a unique double-layer spring design for the female contact al-

so ensures heat and vibration resistance suitable for internal automotive connections, resulting in a highly reliable connector. The ZH05 is a compact product that provides greater battery capacity.

### Wire-to-Board Connector for Electric Shock Prevention

- Electric shock protection design in which the female contacts on the board side of the connector are surrounded with resin.
- 125°C heat resistance and unique double layer spring design ensure vibration resistance and high contact reliability.
- 0.5mm tab, narrow width with 2.0mm pitch, space saving, helps maximise battery capacity.

### Features

- Contact pitch [mm]: 2.0
- Height [mm]/Depth [mm]: 9.8/18
- Rated Current [A]: 2
- Rated Voltage [V] : AC/DC 60
- Operating temperature [°C]: -40 to +125
- Number of contacts: 12, 16, 20, 24\*
- Mating cycles: 30
- Termination AWG / Applicable cable: 22-24
- Contact plating specification: Tin

S10

Julia Reiterer, +43 1 86305 162  
julia.reiterer@codico.com

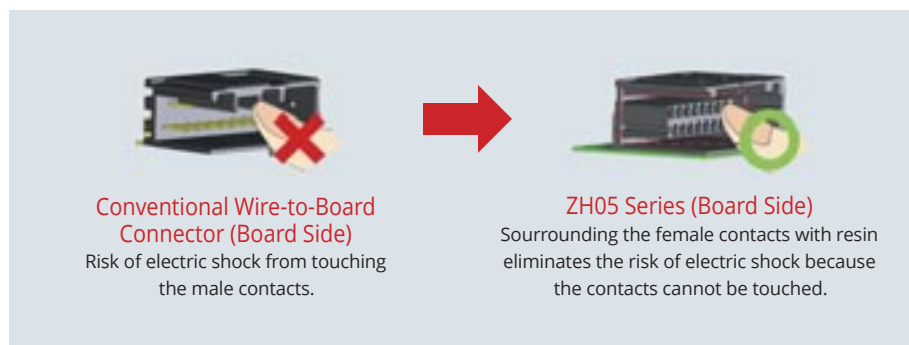



# M8



## Hybrid Single Pair Ethernet Cable Assemblies

The small size M8 connector from SINBON combines power transmission up to 8A with the new Single Pair Ethernet Technology. The hybrid cable assemblies depict a perfect balance of speed, distance and power delivery for a wide variety of IIoT projects.

SINBON offers the cable assemblies in standard lengths of 0.5, 1 and 2m. Of course, any other length is possible, too. Also, different angles for the SPE connectors, including 90° and 180°, are available for order.

Secure mating is guaranteed by the advantages of bayonet locking mechanism such as quick and easy mating, tactile and acoustic feedback after the connector is locked and resistance to vibration during operation.

To respond to the current industry trends of miniaturization and material-saving, SINBON team managed to reduce the size of the connector by 35%. In terms of overmold, the size was reduced from 5.7g to 3.5g. Also mating plugs in panel mount version are available from SINBON.

### Features

- Bayonet locking mechanism
- Cable plugs in straight and right-angled version
- 2x8A (Power) & 2x4A (Signal)
- IP67 (mated) & IP65 (unmated)
- 500 mating cycles

### Verification standards

IEC63171-6 Ed. 1.0  
 IEEE 802.3bu  
 IEEE 802.3bp (1000 BASE-T1)  
 IEC 60512-2-3 Test 6c Shock Test  
 IEC 60512-6-4 Test 6d Vibration Test  
 IEC 60512-9-1 Test 9a Endurance Test  
 IEC 60332-1-2 Flame Resistant Test  
 IEC 60811-404 Oil Immersion Test

SINBON is a member of Single Pair Ethernet Partner Network, an equal association of companies that promotes Single Pair Ethernet technology as the basis for rapid and successful growth of the IIoT (Industrial Internet of Things). Originally created for the automotive industry, SPE now depicts a perfect balance of speed, distance and power delivery for a wide variety of IIoT projects.

Ethernet has already been the most popular communication protocol in LAN applications since

### HIGHLIGHTS

- Innovative - a key enabling technology for Industry 4.0 and IIoT
- Cost-effective - reduces total installation costs by 25%
- Lighter and thinner - 2 to 3 times smaller than a 4-pair Ethernet cabling
- Fast connection - transmission characteristics of up to 1Gbit/s
- Cross-application - can be used across various applications

the 1980s, and since then it has been persistently advancing into new fields of application. Ethernet has the fastest transmission of information via TCP/IP and has a wide application in various fields.

S11

▶ *Barbara Schanda, +43 1 86305 152  
 barbara.schanda@codico.com*







# REVOLUTION

## Precision Motors Without the Premium Price Tag

PIEZO MOTION's patented standing wave-type piezoelectric motors & actuators can replace traditional small-size precision rotary and linear motors as well as actuators. They are the perfect match for applications that need significant performance improvements with increased energy efficiency.

### How does the piezo technology work?

The word piezo comes from the Greek word piezein – to squeeze or press. A piezoelectric effect is the ability of some materials, often piezo ceramics, to generate an electrical charge in response to mechanical force (squeezing or pressing). The piezoelectric effect is reversible, so materials exhibit »the inverse piezoelectric effect« – in which they change shape or size when excited by an electric charge. Although the inverse piezoelectric effect has been professionally studied for some years, practical applications of piezo technology in everyday devices like digital cameras, industrial valves, and toys have only been relatively recent.

As the demand for better energy efficiency, higher performance, more miniaturisation and greener technology grows, companies are shifting their focus to piezo motor technology as an alternative to conventional electromagnetic motors. This efficient and economical technology offers the answers to many modern-day problems at an affordable price.

There are several types of piezo motors on the market; however, PIEZO MOTION's design and technology produce unique standing wave-type piezo motors that provide certain key advantages in use and manufacturability. PIEZO MOTION motors come in various sizes and configurations, and the company's full line of rotary and linear

piezo motors addresses many of today's requirements for motion control systems.

Whether rotary or linear, PIEZO MOTION's motors work on the same principle of ultrasonic standing waves, which cause electrically induced excitation within a piezoelectric resonator/ceramic. PIEZO MOTION's Blue series targeting is precise, lightweight, compact and reliable whilst designed for volume manufacture making them ideal for OEM applications.

PIEZO MOTION's motors operate under a patented principle of excitation that uses two right-angled or orthogonal vibration modes (with relative phase difference). The two modes of vibration cause the piezoceramic to oscillate in a way that, when harnessed, it enables the creation of precise continuous rotary and linear motion. Furthermore, this technique (which is part of PIEZO MOTION's IP portfolio) greatly simplifies drive circuit design and requires very low voltages, re-



© Adobe Stock/Garantekoff



PIEZOMOTION



PIEZO MOTION's Blue Series

ducing the drive electronics cost. The innovative technology combined with rigorous design philosophy, utilizing a combination of piezoceramics, modern materials and manufacturing enables the company to produce precision motion products at a competitive cost.

Compared to conventional DC motors, piezo technology offers high performance, namely >1000X's better resolution, >100X's Faster Reaction Time and >10X's greater specific power stall torque.

### Advantages of piezo motors from PIEZO MOTION

- **Energy and cost savings**  
Low voltage (e.g. 12VDC, customisable down to 5VDC) and higher energy efficiency  
Designed for direct-drive applications where a gearbox is completely unnecessary
- **Scalable in design**  
Rotating and linear, can be operated silently and consume zero energy in the hold position.
- **Non-magnetic**  
Ideal for applications where conventional DC motors cannot be used (e.g. medical MRI).
- **Low operating costs**  
Highly competitive in price  
Further operating cost reduction due to simplified driver electronics
- **Environmental**  
Immune to electromagnetic interference (EMI/RFI) and contain no »rare earth elements« (REE).

S12

▶ Christian Sichtar, +43 1 86305 134  
christian.sichtar@codico.com



PIEZO MOTION's Blue Series



# ECO-TRONIC PL

## The Safely Latching Connector for FR4 PCBs

ECO-TRONIC PL from STOCKO Contact stands for **Power Lock**. It is a high performance addition to the RAST 2.5 ECO-TRONIC connector series for the automotive industry.

The primary areas of use for this new connector are LED and display applications as well as the interior sector. Of course, it can be used for other applications like the contacting of actuators too. Its innovative locking design enables a holding force of the direct connector with insu-

lation displacement connection of impressive 80N. The contact design guarantees a stable mechanical and electrical connection between contact and conductor with 0.22 and 0.35mm<sup>2</sup>. Displace security by polarisation elements and mechanical barriers against damage of contacts by

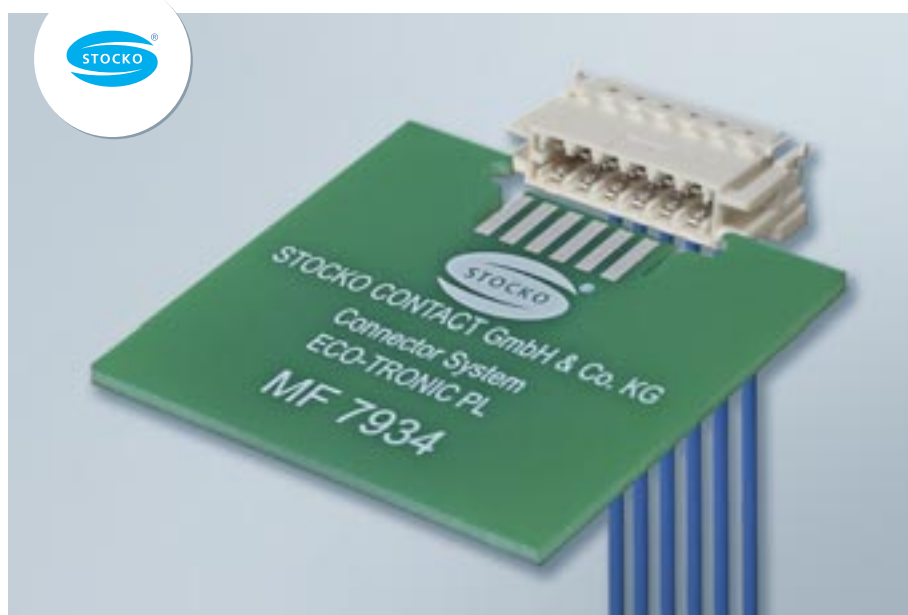

### HIGHLIGHTS

- Direct connector system with IDC technology
- Fulfils requirements of automotive industry
- Coding
- Locking between plug and PCB
- The end position of the insertion is tactile
- Fulfils the list of illegal basic materials acc. to REACH
- GWT 750°C acc. IEC 60335-1

disoriented mating ensures the quality of the connection in use and in application.

In addition, an automatic processing of the connector system ensures the high quality standard over the whole manufacturing process.

#### TECHNICAL DATA

- Pitch: 2,50mm
- Positions: 3-12
- Board thickness: 1,50 ±0,14mm / 1,60 ±0,14mm
- Wire size: 0,22mm<sup>2</sup> and 0,35mm<sup>2</sup>
- Insert cycles: 5
- Current rating: 4A (85°C/0,35mm<sup>2</sup>)  
nominal voltage: 32V (Raster 2,5mm)

Approvals:  
Acc.to LV 214 und USCAR2

S13

▶ Barbara Schanda, +43 1 86305 152  
barbara.schanda@codico.com



# TOUGH GOING

## New RJ45 Metal Cover with IP69K Protection & Push-Pull Locking System



The RJ45 series Y-Con from YAMAICHI Electronics was developed for the toughest industrial applications and is a flexible, modular and expandable product line. It meets the requirements of protection ratings IP20, IP67, IP68 and IP69K, among others.

Within the product line, the Y-Con Cover-40, which has been established for years, has now been replaced by a new metal cover, namely the Y-Con Cover-40 PP with push-pull locking. It facilitates and simplifies handling, with the cover automatically locking or unlocking during the plugging or unplugging process.

The new cover also complies with protection ratings IP67/ IP68/ IP69K and is therefore suitable for the harshest industrial environments. It is characterised by high robustness, temperature resistance and durability and is largely protected against vibrations. Reliable data and optional power transmission is thus reliably guaranteed. Of course, the new cover is backwards compatible with the components used so far. This means that IP67/ IP68/ IP69K components already in use can also be connected to the new connector system.

The metal cover can be installed in the usual simple self-assembly manner with Y-Con cable plugs and cables. The reduction of individual parts has also reduced complexity and the error rate during assembly.

In addition, the new version offers an enlarged sealing surface and improved EMI protection. Furthermore, the new cover allows the proces-

sing of different cable diameters from 6.1 to max. 7.1mm.

The Y-Con RJ45 is the only industrial connector system for Industrial Ethernet, Profinet and field-buses that optionally includes two additional, fully integrated contacts for power supply based on the RJ45 specification. Up to 3.1A can be reliably transmitted via these.

S14

▶ Christian Sichtar, +43 1 86305 134  
christian.sichtar@codico.com

### HIGHLIGHTS

- Easy handling due to new push-pull locking mechanism for vibration-proof RJ45 connections
- Fewer individual parts allow quick and easy assembly
- Lock can be released with screwdriver
- Robust metal housing made of zinc die-cast with high mechanical stability
- Stainless steel locking hooks
- Protection rating IP67/68/69K
- Two optional additional power contacts with up to 3.1A current transmission
- Increased EMI protection
- Adapter cables with M12 (Y-Circ M) or metallic push-pull connectors (Y-Circ P) available
- Operating temperature -40 to +120°C



YAMAICHI's Y-Con

# The CODICO TEAM says hello!

## Florence Ortolan



Dear Impulse Readers, after 10 years training 6 hours per day everyday on the ice (I am a former ice-skater) and 20 years travelling and living all over the world for my studies and professional life, I was ready to follow the idea of my former colleague Michael Blaha to apply for an open request at CODICO as Field Sales Engineer for France.

CODICO had nobody in France for the Passive Components five years ago. Everything needed to be implemented, and the concept of Design-In activity of the company was particularly interesting for me.

I love working on projects (and see the results!), being at the customer's own location to find with him some ideas for his design or problem. At CODICO, we can concentrate on the application, building technology. In close cooperation with our team of technical experts and suppliers, we can keep ourselves up to date on the market, and provide the customer with the best technical and commercial solution for their particular need as well as presenting new, innovative products.

CODICO is also a company where a respectful behaviour toward the employees and the customers really means something. The human relationship is here!

So now, I have this great job. I moved from Paris to my old countryside house in wood and stones dating from the French revolution. When I am not travelling, I enjoy my huge garden with my own vegetables, fruits, eggs and all the different places to laugh with my friends, to play with my dog, or to do yoga in front of the sunlight.

The last word, I would like to add is »Thank you«:

- To you, Michael for the opportunity
- To you, Karin and Sven for this great working environment
- To you, my Manager and colleagues for the friendly cooperation and support
- & To you, Impulse reader for reading this magazine until the last page!

**D02**

▼ Florence Ortolan, +33 982581994  
florence.ortolan@codico.com

## Romano Müllner

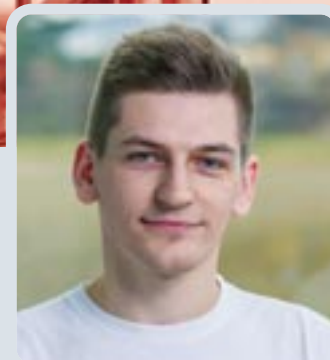

Dear Impulse Readers, I have been with CODICO for more than 5 years now and I am pleased to introduce myself to you today. After school I did an apprenticeship as a locksmith, but then in the course of the apprenticeship I came to the conclusion, that this was not the right profession for me. That's why I started working in the warehouse at the Mediaprint publishing house. I was soon in charge of the night and weekend shifts. After a few years, however, the working hours associated with it no longer met my expectations. After I came across a job advertisement for a warehouse worker at CODICO, I became part of the CODICO family in October 2017.

Working in our warehouse covers a wide range of activities and work processes. We have several areas where diverse activities and requirements are in demand. Since these always differ according to the supplier or the customer, in addition to the physical activity, thinking along with the customer is always required and demanded. Since we have a rotation principle, we are entrusted with different tasks every week. This variety and the ever-new challenges to overcome together with our team offer a certain appeal and that is why I enjoy coming to work every day.

In my free time, I am very interested in the world of cars and like to drive them all over Austria. Because of my passion for cars and driving in general, I also like to be assigned tasks at CODICO when it comes to taking care of various errands or also looking after the company's internal fleet. But of course, I'm not always »on the road«, I also like to spend time in my new flat. There I take care of my flatmate, Gizmo the cat, and you can also find me quite often in the virtual world.

Even if you wouldn't guess it at first glance, the culinary world also holds a great attraction for me. You can say that I like to eat well. Since we have our own "bonnet kitchen" at CODICO and receive a free lunch every day, this is of course very convenient for me.

In conclusion, I am happy to be part of the CODICO family and look forward to many more years with the company.

**D03**

▼ Romano Müllner, +43 1 86305 190  
romano.muellner@codico.com

## Helmut Schweigreiter



Dear Impulse Readers, when I was asked to write a short text for the CODICO Impulse, the first thing I did was to ponder how long I had actually been here at this company. And indeed: In December it will already be five years that I have been working for CODICO in Perchtoldsdorf. Yet it feels like it was yesterday, because time has been flying by.

Together with my six colleagues, I am responsible for the smooth operation of the entire IT infrastructure. We renew hardware and software and also handle projects such as automatic data exchange with customers and suppliers (EDI). Of course, the support and training of our colleagues is also very important to us.

For us in the IT group, one goal is always in the foreground: "The systems must run". Why, can be discussed later in peace and quiet. It's great to be part of a team whose members come from a wide range of disciplines, because in IT in particular it's an advantage when problems are looked at and analysed from all possible angles. It is fun to »argue« with colleagues on a technical level and to debate their respective points of view in order to come to a joint result. No matter how big the differences in content are, it never becomes personal or even undermining. That is what ultimately moves us forward.

I myself am the father of two children of high school and primary school age, so home office and flexitime are sometimes indispensable. It's nice that both are possible at CODICO without any problems. In this context, too, we stick together as a department and support each other as much as we can. Because family is not just a buzzword at CODICO, but really a value that is lived and respected by everyone.

When I joined the company, there was still no sign of the pandemic. But when it hit us with full force, our team spirit and joint efforts made it possible for the entire headquarters staff to switch to home office practically overnight. Experiences like this are the salt in the soup that make us want to stay with CODICO for many more years - but without a lockdown, if possible. As a balance to the sometimes-stressful job, I like to go skiing or cycling with the children, run with them through woods and meadows or relax with the whole family in the weekend house by the lake. There you can also enjoy chestnuts and »Schilchersturm« in autumn and the world is a little more in order again.

D04

▶ Helmut Schweigreiter, +43 1 86305 231  
helmut.schweigreiter@codico.com

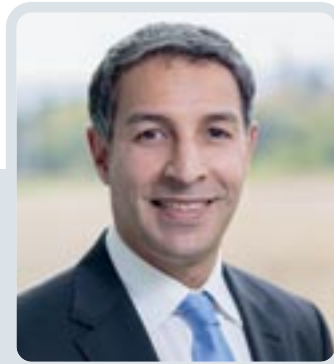

## Samir Lamchaouri

Now it's my turn to introduce myself to our loyal readers in our Impulse magazine. My name is Samir Lamchaouri. I am 46 years old, a husband and father of two children. I live in beautiful Mühldorf am Inn, which is located between Munich and Passau. I grew up in Germany and Morocco and was thus able to attend two different school systems and get to know different languages and cultures. After the French baccalaureate, I started studying economics. My educational background is therefore commercial, but I have always been interested in technology - which ultimately paved the way for me to enter the big, colourful world of electronics. The fact that I ended up in distribution was a pure coincidence that still captivates me and makes me curious until today. I was able to gain experience at the companies Spoerle, Arrow and Future Electronics. My network got bigger and bigger over time. I value good communication with colleagues, customers and suppliers. I always seek contact with people and listen to them. I am a thoroughly optimistic person. At the same time, I am also rational and try to think pragmatically and realistically. If there are topics for discussion, I try to approach them with the necessary sensitivity, because a wrong sentence can cause a lot of damage, and unfortunately so can a right sentence at the wrong moment. I am open to change, able to learn and adapt, because the world and things around us are continuously changing. Lately at a very fast pace. I find balance in my hobbies. This includes sports - especially football, fitness and badminton, reading, jogging, travelling and getting to know new cultures. Besides that, I am also interested in the world of finance, economic and corporate data and the stock market.

I control my sales territory in Bavaria and Thuringia from my home office. This new way of working was a new step at the time and an experience I was happy to take on, because for me the balance between work and family has always been very important. The professional, pleasant initial discussions and the site visits tipped the scales in my favour back then to start my professional career at CODICO. How quickly time has passed since then! It is hard to believe that I have been employed here for 5 years now. I started my job in August 2017 as a sales engineer for electronic components. In itself, nothing new for me, but the focus only on passive components as well as the direct communication wire to the manufacturer were new to me. This concept and the focus on the customer application are lived at our company in order to accompany the customer from the first development phase to the final product. I felt comfortable and welcome from the very first day. I had a mentor at my side right from the start. An extremely great thing to find your way around in the initial phase. Through the regular meetings at the headquarters, there is a lively exchange of knowledge and information. We laugh a lot, take part in events and dinners together. I look forward to it every time. Reflecting back, I experienced an exciting time with beautiful, but also sometimes difficult challenges, exciting projects and applications and an open company culture. Communication has always been clear and open. The internal cooperation is characterised by the motto »We live family«, »We are dynamic« and »We bear responsibility«. These sentences represent the CODICO values and so I am a proud part of a great family that I appreciate and where one is valued.

D05

▶ Samir Lamchaouri, +49 8631 9888828  
samir.lamchaouri@codico.com





**CODICO GmbH** | Zwingenstrasse 6-8 | 2380 Perchtoldsdorf | Austria

Phone: +43 1 86 305-0 | Fax: +43 1 86 305-5000

office@codico.com | [www.codico.com](http://www.codico.com)